

# Flex S

## Mounting Arm for weather stations, 1 ball-joint

### Technical specifications and installation instructions

Item number 30119



## 1. Description

Use the **Mounting Arm Flex S** to mount the weather stations and sensors flexibly on the wall. The following weather stations can be attached to the mounting arm:

- Suntracer KNX (basic) and Suntracer KNX-GPS weather stations, plus KNX-weather sensors
- Weather stations for the Solexa, Solexa II and Arexa controls
- Weather station P03-RS485 and RS485-weather sensors
- Weather station P03-Modbus
- Suntracer KNX sl (including light and basic) weather stations and KNX sl-weather sensors
- P04i-GPS weather station (WS1/WS100 Color/Style and KNX WS1000 Style controllers)
- P04-RS485 weather stations
- KNX Vari sensors

### 1.0.1. Deliverables

- Mounting arm with plate for wall installation and plate for the weather station
- 2x cylinder head screw DIN 912 M4x20 stainless steel version for Vari
- 2x cylinder head screw DIN 912 M4x25 stainless steel version for P04/Suntracer sl
- 2x cylinder head screw DIN 912 M4x8 stainless steel version for P03/Solexa/Suntracer
- 2x washer DIN 125 4.3 stainless steel version (is required for all variants)

### 1.1. Technical specifications

|              |   |
|--------------|---|
| Colour       | Powder coated white RAL 9003 satin finish |
| Joints       | 1 ball-joint 25°                          |
| Total length | approx. 64 mm                             |
| Weight       | approx. 152 g                             |

The product conforms with the provisions of EU directives.

## 2. Assembly



### ATTENTION!

**Do not open the ball-joint!**

If the ball-joint is opened the pressure spring and the plastic counter-bearing can be lost.

Only use suitable fixing material (screws, dowels) to fix the wall installation plate and make sure that the subsurface is stable.

### 2.1. Dimensions

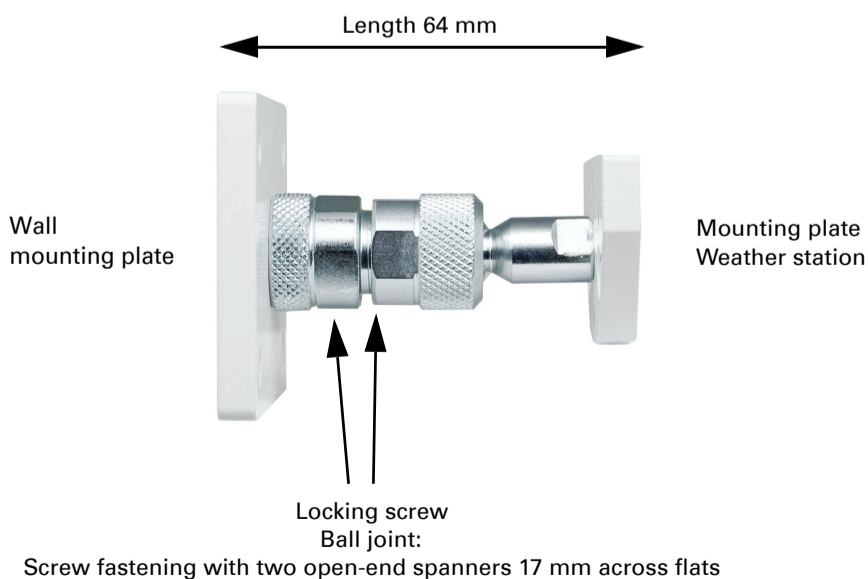

### Wall mounting plate:



Abb. 1  
Hole diameter 6.2 mm

## 2.2. Affix sensor

### 2.2.1. Type P03/Solexa/Suntracer

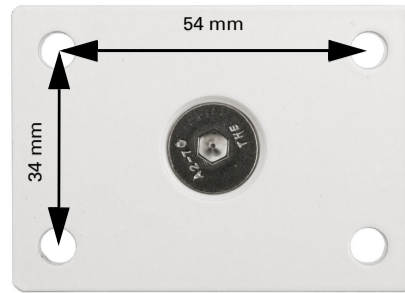

Abb. 2  
For mounting use the cylinder head screws DIN 912 M4x8 and place the DIN 125 washers under the screw heads.

Abb. 3

Mounting plate sensor

Holder type P03/Solexa/Suntracer

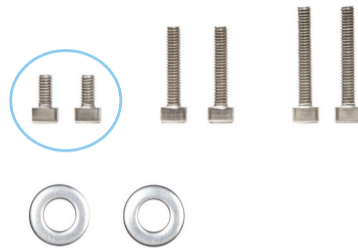
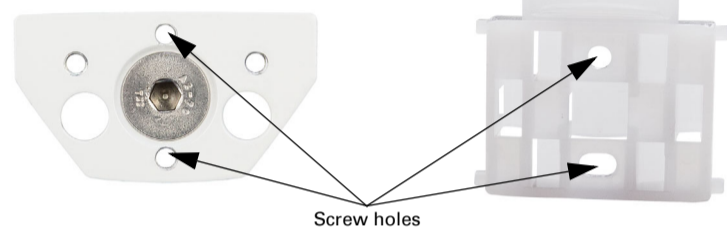

Screw holes



Abb. 4

Slide the weather station housing from above on to the holder mounted on the plate. In doing this, the studs in the holder must click into the tracks on the casing.

### 2.2.2. Type P04/Suntracer sl – connection system 2018



Abb. 5  
For mounting use the cylinder head screws DIN 912 M4x25 and place the DIN 125 washers under the screw heads.

Abb. 6

Mounting plate sensor

Mount P04/Suntracer sl

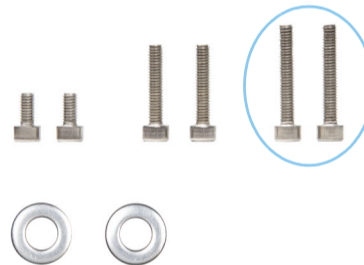
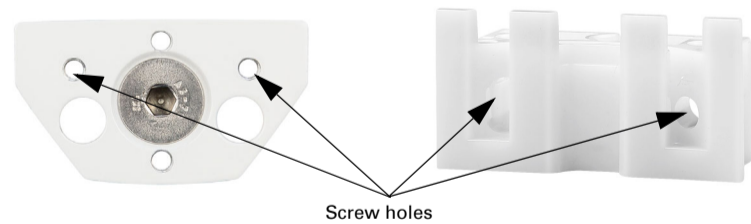

Screw holes

Lower the device onto the mount. Tighten the screw of the mount to secure the device.

### 2.2.3. Type Vari



Abb. 7  
For mounting use the cylinder head screws DIN 912 M4x20 and place the DIN 125 washers under the screw heads.

Abb. 8

Mounting plate sensor

Rear side Vari

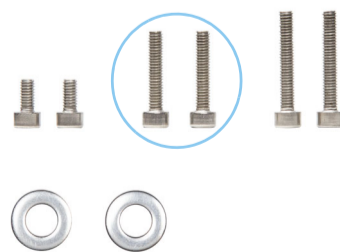
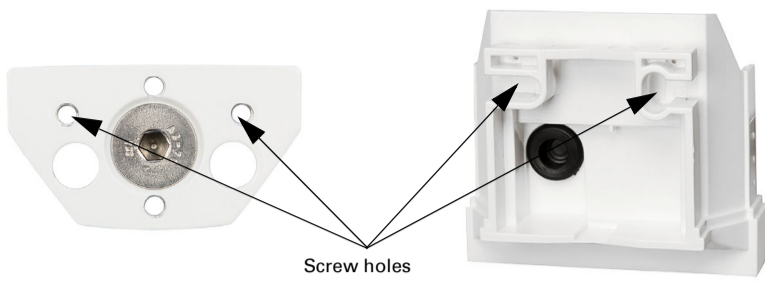

Screw holes

The holes in the lower part of the housing must be carefully broken out for the screw fastening. The lower part of the housing is screwed together with the sensor mounting plate from the inside.