

# Intra-Sewi KNX L-Pr and Intra-Sewi KNX TH-L-Pr Brightness and Presence Detectors

## Technical specifications and installation instructions

### Item numbers

- 70670 Intra-Sewi KNX L-Pr, white
- 70672 Intra-Sewi KNX L-Pr, black
- 70680 Intra-Sewi KNX TH-L-Pr, white
- 70682 Intra-Sewi KNX TH-L-Pr, black

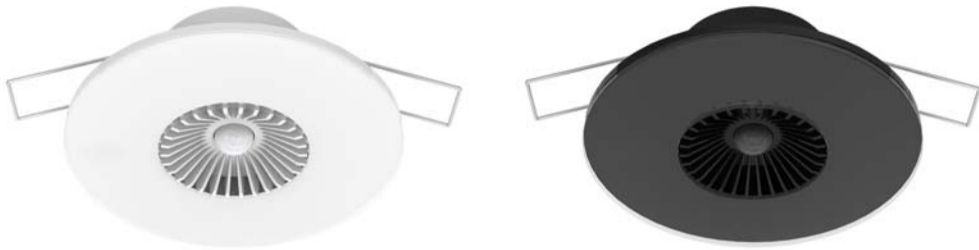

## 1. Description

The **Sensor Intra-Sewi KNX L-Pr** for the KNX building bus system captures brightness and motion in rooms.

The **Sensor Intra-Sewi KNX TH-L-Pr** additionally measures the temperature and the air humidity and calculates the dew-point. Via the bus, the indoor sensor can receive external values of temperature and humidity and process them further with its own data to a total value (mixed value, e.g. room average). Integrated PI-controllers control ventilation (humidification/dehumidification according to humidity) and heating/cooling (according to temperature).

The **Sensor Intra-Sewi KNX TH-L-Pr** can output a warning to the bus as soon as the comfort field, as per DIN 1946, is left. Actuating variable comparators can compare and output variables that were received via communication objects.

All measurement values can be used for the control of limit-dependent switching outputs. States can be linked via AND logic gates and OR logic gates.

### Functions:

- **Brightness measurement with brightness control**
- **Motion detection**
- **Threshold values** can be adjusted per parameter or via communication objects
- **4 AND and 4 OR logic gates**, each with 4 inputs. All switching events as well as 16 logic inputs (in the form of communications objects) can be used as inputs for the logic gates. The output of each gate can be configured optionally as 1-bit or 2 x 8-bit

### Additional functions Intra-Sewi KNX TH-L-Pr:

- Measuring the **temperature** and **air humidity** (relative, absolute), each with **mixed value calculation**. The share of internal measurement value and external value can be set as a percentage
- Bus message, whether the values for temperature and air humidity are within the **comfort field** (DIN 1946). **Dew point** calculation
- **PI-controller for heating** (one or two-stage) and **cooling** (one or two-stage) according to temperature. Regulation according to separate setpoints or basic setpoint temperature
- **PI controller for humidity** according to humidity: **Ventilate/Air** (one-stage) or **Ventilate** (one or two-stage)
- **2 actuation variable comparators** to output minimum, maximum or average values. 5 inputs each for values received via communication objects

Configuration is made using the KNX software ETS. The **product file** can be downloaded from the Elsner Elektronik website on [www.elsner-elektronik.de](http://www.elsner-elektronik.de) in the "Service" menu.

### 1.0.1. Scope of delivery

- Sensor
- Pre-assembled clamps for false ceiling installation
- Support ring for connector socket installation

For socket installation you will need *in addition* (not supplied):

- Socket Ø 60 mm, 42 mm deep

## 1.1. Technical data

|                     |   |
|---------------------|---|
| Housing             | Plastic, glass  |
| Colour              | <ul style="list-style-type: none"> <li>• similar to signal white RAL 9003</li> <li>• similar to jet black RAL 9005</li> </ul> |
| Assembly            | built-in, in false ceiling or connector socket  |
| Protection category | IP 30   |
| Dimensions          | Ø approx. 80 mm;<br>height above wall approx. 5 mm<br>height in wall (installation) approx. 31 mm (incl. clamps)              |
| Total weight        | approx. 50 g  |
| Ambient temperature | Operation -20...+60°C, storage -20...+70°C  |
| Ambient humidity    | max. 95% RH, avoid condensation   |
| Operating voltage   | KNX bus voltage   |
| Bus current         | max. 10 mA  |

|   |   |
|---|---|
| Data output                                       | KNX +/- bus plug-in terminal  |
| BCU type  | Integrated microcontroller  |
| PEI type  | 0   |
| Group addresses                                   | max. 254  |
| Assignments                                       | max. 254  |
| Communication objects                             | Intra-Sewi KNX TH-L-Pr: 252<br>Intra-Sewi KNX L-Pr: 122                                   |
| Brightness sensor:                                |   |
| Measurement range                                 | 0 lux ... 2,000 lux (higher values can be measured and displayed)                         |
| Resolution  | 1 lux at 0...2,000 lux  |
| Accuracy  | ±15% of the measurement value at 30 lux ... 2,000 lux                                     |
| Motion sensor:                                    |   |
| Coverage angle                                    | approx. 94° × 82° (see also <i>Coverage area of the motion detector</i> )                 |
| Range   | approx. 5 m   |
| Temperature sensor (only Intra-Sewi KNX TH-L-Pr): |   |
| Measurement range                                 | -20°C ... +60°C   |
| Resolution  | 0.1°C   |
| Accuracy*   | ±0.7°C at -20°C...-10°C<br>±0.5°C at -10°C...+60°C  |
| Humidity sensor (only Intra-Sewi KNX TH-L-Pr):    |   |
| Measurement range                                 | 0% rH ... 100% rH   |
| Resolution  | 0.1% rH   |
| Accuracy  | ± 7,5% rH at 0% ... 10% rH<br>± 4,5% rH at 10% ... 90% rH<br>± 7,5% rH at 90% ... 100% rH |

The product is compliant with the provisions of the EU guidelines.

### 1.1.1. \*Measuring accuracy

Deviations in measured values due to interfering sources (see chapter *installation location*) must be corrected in the ETS in order to achieve the specified accuracy of the sensor (offset).

During the **Temperature measurement**, the self-heating of the device is taken into consideration by the electronics. It is compensated by the software, therefore the displayed/output indoor temperature measuring value is correct.

## 2. Installation and start-up

### 2.1. Installation notes



Installation, testing, operational start-up and troubleshooting should only be performed by an electrician.



### CAUTION! Live voltage!

There are unprotected live components inside the device.

- National legal regulations are to be followed.
- Ensure that all lines to be assembled are free of voltage and take precautions against accidental switching on.
- Do not use the device if it is damaged.
- Take the device or system out of service and secure it against unintentional use, if it can be assumed, that risk-free operation is no longer guaranteed.

The device is only to be used for its intended purpose. Any improper modification or failure to follow the operating instructions voids any and all warranty and guarantee claims.

After unpacking the device, check it immediately for possible mechanical damage. If it has been damaged in transport, inform the supplier immediately.

The device may only be used as a fixed-site installation; that means only when assembled and after conclusion of all installation and operational start-up tasks and only in the surroundings designated for it.

Elsner Elektronik is not liable for any changes in norms and standards which may occur after publication of these operating instructions.

### 2.2. Installation location



**Install and use only in dry interior rooms!** Avoid condensation.

The Sensor is installed in a false ceiling or a standard connection socket (Ø 60 mm, 42 mm deep).

The device must be installed on the ceiling, so that the **movement capturing** takes place from above. Make sure that the desired area is covered by the sensor's coverage angle and that no obstacles obstruct the recording.

When selecting an installation location of **Intra-Sewi KNX TH-L-Pr**, please ensure that the measurement results of **temperature and humidity** are affected as little as possible by external influences. Possible sources of interference include:

- Direct sunlight
- Drafts from windows and doors
- Draughts from ducts coming from other rooms or the outdoors
- Warming or cooling of the building structure on which the sensor is mounted, e.g. due to sunlight, heating or cold water pipes

- Connection lines and empty ducts which lead from warmer or colder areas to the sensor

Measurement variations from such sources of interference must be corrected in the ETS in order to ensure the specified accuracy of the sensor (offset).

### 2.2.1. Coverage area of the motion detector

Angle of coverage: approx. 94° x 82°  
Range: approx. 5 m

#### Segmentation of the coverage area

Fig. 1

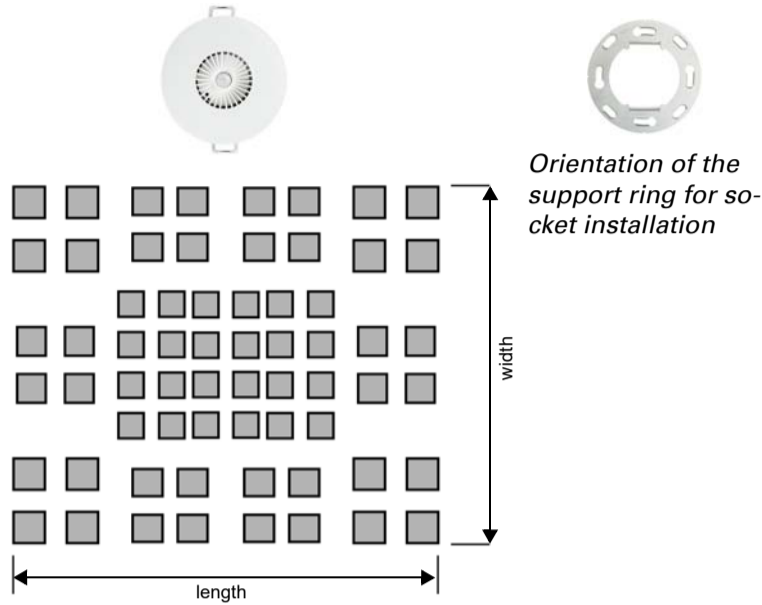

#### Size of the coverage area

| Distance | Length         | Width          |
|----------|----------------|----------------|
| 2.50 m   | approx. 5.40 m | approx. 4.30 m |
| 3.50 m   | approx. 7.50 m | approx. 6.10 m |

## 2.3. Installation of the sensor

### 2.3.1. Installation in false ceiling

Connect the bus line to the KNX terminal (red/black).

Place the device in the installation opening in the ceiling. For this, fold the clamps upwards and guide the device through the installation opening with the clamps first.

The device is automatically fixed by the clamps.

Fig. 2

- 1 Clamps for installation in false ceiling
- A Height in wall (built-in): approx. 31 mm
- B Space behind the false ceiling, necessary for insertion (clear dimension): approx. 31 mm
- C Maximum wall thickness: 20 mm
- D Hole size for installation: 50...65 mm

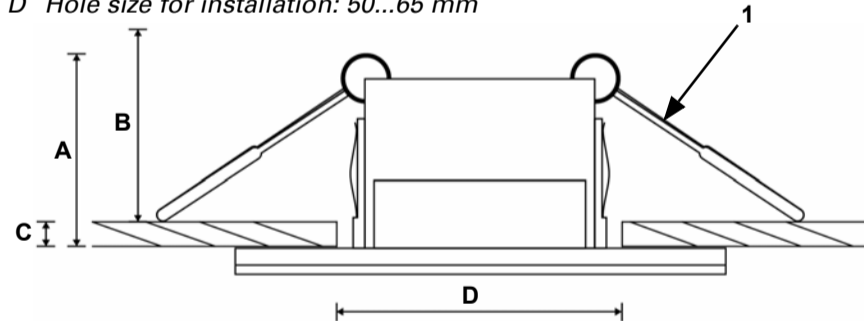

### 2.3.2. Installation in connector socket

Before socket installation, remove the clamps for the false ceiling installation.

Screw the support ring onto the socket. Pay attention to the orientation as shown in the chapter *Coverage area of the motion detector*.

Connect the bus line to the KNX terminal (red/black).

Clamp the device in the support ring so that the springs on the device snap over the tabs of the support ring.

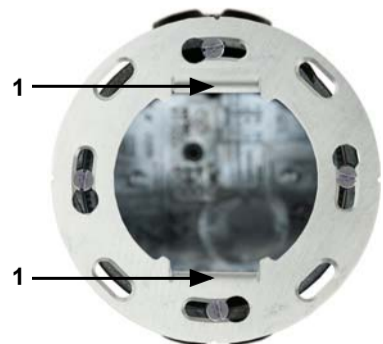
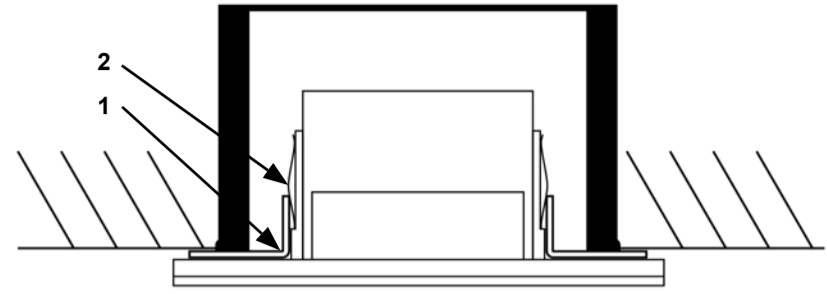

Fig. 3: Tragrung  
1 Tabs

Fig. 4

Connector socket with Ø 60 mm, 42 mm deep.

- 1 Support ring, screwed to the socket
- 2 Springs hold the device firmly on the support ring



### 2.3.3. Back view: connection

The connection is made with the KNX terminal (red/black) to KNX TP.

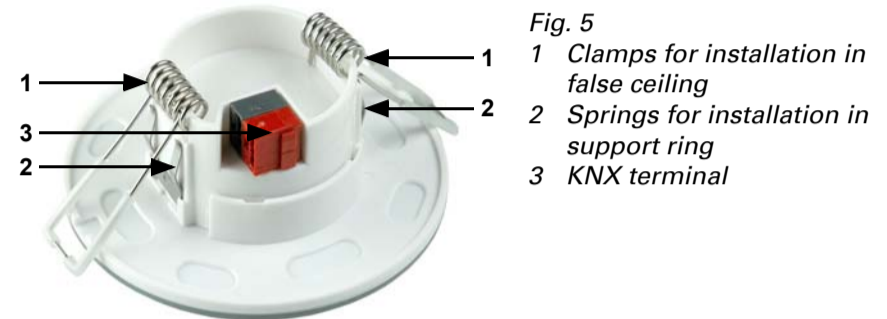

Fig. 5

- 1 Clamps for installation in false ceiling
- 2 Springs for installation in support ring
- 3 KNX terminal

### 2.3.4. Front view: programming and addressing

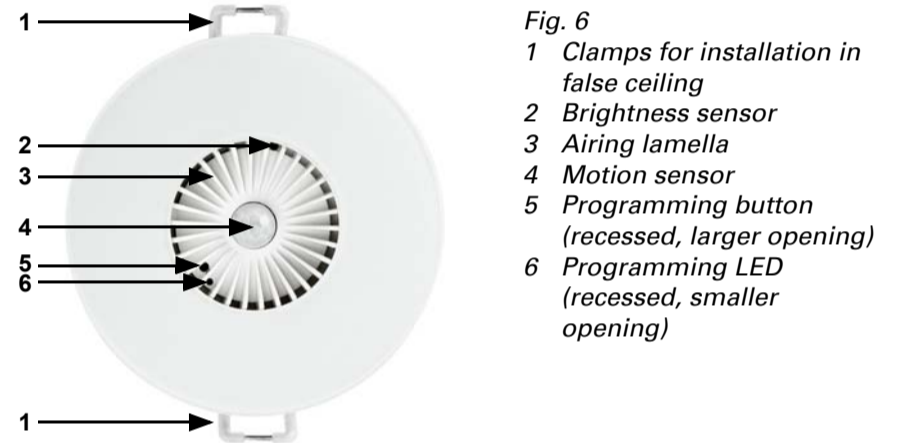

Fig. 6

- 1 Clamps for installation in false ceiling
- 2 Brightness sensor
- 3 Airing lamella
- 4 Motion sensor
- 5 Programming button (recessed, larger opening)
- 6 Programming LED (recessed, smaller opening)

The equipment is delivered with the bus address 15.15.255. You can program a different address in the ETS by overwriting the address or by teaching the device via the programming button.

The programming button is located between the airing lamella (Fig. 6: No. 5).

## 2.4. Notes on mounting and commissioning

Never expose the device to water (e.g. rain) or dust. This can damage the electronics. You must not exceed a relative humidity of 95%. Avoid condensation.

The airing lamella must not be closed or covered. The device must not be painted over.

After the bus voltage has been applied, the device will enter an initialisation phase lasting a few seconds. During this phase no information can be received or sent via the bus.

The motion sensor has a start-up phase of approx. 15 seconds during which no motion detection takes place.

## 3. Maintenance

The brightness and movement sensor and the airing lamella must not get dirty or covered. As a rule, it is sufficient to wipe the device with a soft, dry cloth twice a year.