

Flat vT & Flat 55 vT

2/4/6-Button Capacitive Touch Panel

2/4-Button 55x55mm Capacitive Touch Panel

**ZVIF2VT / ZVIF4VT / ZVIF6VT
ZVIF55X2VT / ZVIF55X4VT**

Application Programme Version: [1.6], [1.5]
User Manual Version: [1.6]_a

CONTENTS

Contents	2
1 Introduction.....	3
1.1 Flat vT / Flat 55 vT.....	3
1.2 Installation	5
1.3 Start-Up and Power Loss.....	7
2 Configuration.....	8
2.1 General	8
2.1.1 Configuration	8
2.1.2 Temperature Sensor	11
2.1.3 Backlight.....	11
2.1.4 Sounds.....	11
2.1.5 Ambient Luminosity Sensor	13
2.1.6 Advanced	13
2.2 Buttons.....	17
2.2.1 Configuration	18
2.2.2 Disabled.....	21
2.2.3 Individual.....	21
2.2.4 Pair	32
2.3 Inputs	38
2.3.1 Binary Input.....	38
2.3.2 Temperature Probe.....	38
2.3.3 Motion Detector	38
2.4 Thermostat	39
ANNEX I. LED Illumination Modes	40
ANNEX II. Communication Objects.....	43

1 INTRODUCTION

1.1 FLAT VT / FLAT 55 VT

Flat vT and Flat 55 vT are KNX **multifunction capacitive touch switch** from Zennio with proximity sensor, luminosity sensor and backlighted buttons.

They are offered at a **reduced size and weight**, with **two, four or six capacitive touch buttons** for Flat vT, and **two or four** for Flat 55 vT (according to the user's needs) with LED backlight to confirm the press of the buttons as well as showing states. Flat 55 vT are designed to be installed in standard mechanism boxes with 55x55 frames.

Flat vT / Flat 55 vT is a fully customisable solution for the control of rooms where user control of air conditioning systems, lighting, blinds, scenes, etc. is required.

The versatility offered by the functionality of buttons is complemented by the **two built-in analogue/digital inputs**, the **internal temperature sensor** (only in Flat vT) and the **thermostat** function, as well as an elegant and **fully customisable design of the front glass** – customers can choose their button icons, texts and colours and even personalise the background with their pictures, logos, etc.

The most outstanding features of Flat vT / Flat 55 vT are:

- **Fully customisable** design of the front glass.
- **2 / 4 / 6** (only in Flat vT) **touch buttons**, which can operate as individual or pair controls:
- **Horizontally or vertically-oriented** configuration (only available for the two-button and six-button models).
- **Light indicator (LED)** for every button.
- **Buzzer** for an audible acknowledgement of user actions (with the possibility of disabling it either by parameter or by object).
- Possibility of **locking / unlocking the touch panel** through binary orders or scenes.

- **Welcome Back object** (binary or scene) which is sent to the KNX bus when a pulsation is detected after a certain period (configurable) of inactivity.
- Built-in **temperature sensor** (only in Flat vT).
- **Ambient luminosity sensor** for brightness automatic adjustment.
- **Proximity sensor** for quick start.
- **Two analogue/digital inputs** (for motion detectors, temperature probes, additional switches, etc.).
- **Thermostat** function.
- **Heartbeat** or periodical “still-alive” notification.

1.2 INSTALLATION

Figure 1 and 2 shows the connection outline of Flat vT and Flat 55 vT respectively:

1. Temperature Probe.
2. KNX Connector.
3. Programming LED.
4. Programming Button.
5. Fixing Clips.
6. Input Connectors.
7. Touch Buttons.
8. Proximity and Luminosity Sensors.

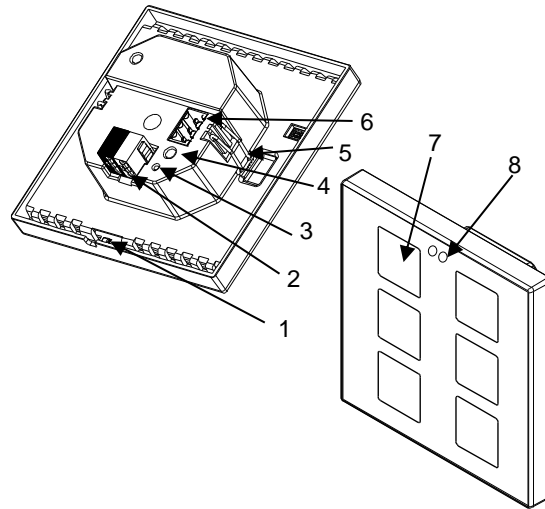

Figure 1 Schematic diagram of Flat vT.

1. Frame (sold separately).
2. Metal leveling plate.
3. KNX Connector
4. Programming LED.
5. Programming Button.
6. Fixing Clips.
7. Input Connectors.
8. Touch Buttons.
9. Proximity and Luminosity Sensors.

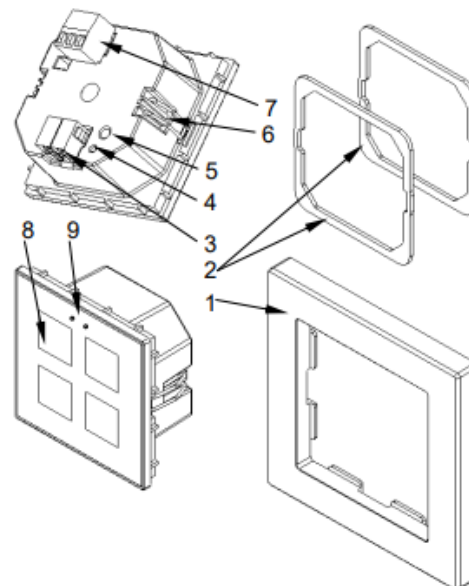

Figure 2 Schematic diagram of Flat 55 vT

Flat vT / Flat 55 vT is connected to the KNX bus through the built-in terminal (2 / 3). An external DC power supply is not needed.

A short press on the **programming button** (4 / 5) will make the device enter the programming mode. The **programming LED** (3 / 4) will then light in red. On the contrary, if this button is held while the device gets connected to the bus, the device will enter the **safe mode**. In such case, the programming LED will blink in red colour.

For detailed information about the technical features of Flat vT / Flat 55 vT, as well as on security and installation procedures, please refer to the device **Datasheet**, bundled within the device packaging and also available at www.zennio.com.

1.3 START-UP AND POWER LOSS

After download or device reset it is necessary to **wait for about 2 minutes without performing any action** in order to make it possible a proper calibration of:

- Proximity sensor.
- Luminosity sensor.
- Button presses.

For a correct calibration of the proximity and brightness sensors it is recommended not to remain too close or place anything less than 50cm approximately and do not hit with direct light to the device during this time.

2 CONFIGURATION

After importing the corresponding database in ETS and adding the device into the topology of the project, the configuration process begins by entering the Parameters tab of the device.

2.1 GENERAL

In order to allow the device to perform the desired functions, a number of options must be parameterized, either related to its **general behaviour** (horizontal/vertical orientation, sounds, LED brightness levels...) or to **advanced features** (lock procedure of the touch panel, cleaning function, welcome back object).

2.1.1 CONFIGURATION

In the "Configuration" tab, the general settings are displayed. Most are checkboxes that enable/disable other functionalities

ETS PARAMETERISATION

The following parameters are shown:

- Device Orientation [Vertical (Normal)¹/Horizontal (Rotated)]**: allows assigning a **horizontal** or **vertical** orientation to the device, making it easier to identify the push-buttons during the configuration process (ETS will show a figure with the final distribution of the push-buttons). To prevent inconsistency in the configuration, please note the following criterium:

Vertical (normal):

Temperature probe hole (only in Flat vT) on the right of the bottom side and the sensors on the middle of the top side.

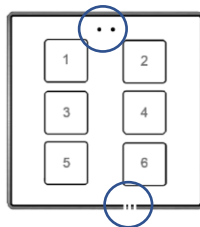

Horizontal (rotated):

Temperature probe hole (only in Flat vT) on the top of the right side and sensors on the middle of the left side.

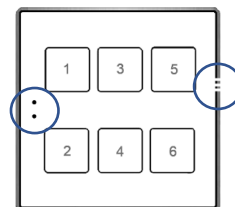

Figure 3 Orientation.

¹ The default values of each parameter will be highlighted in blue in this document, as follows: [default/rest of options].

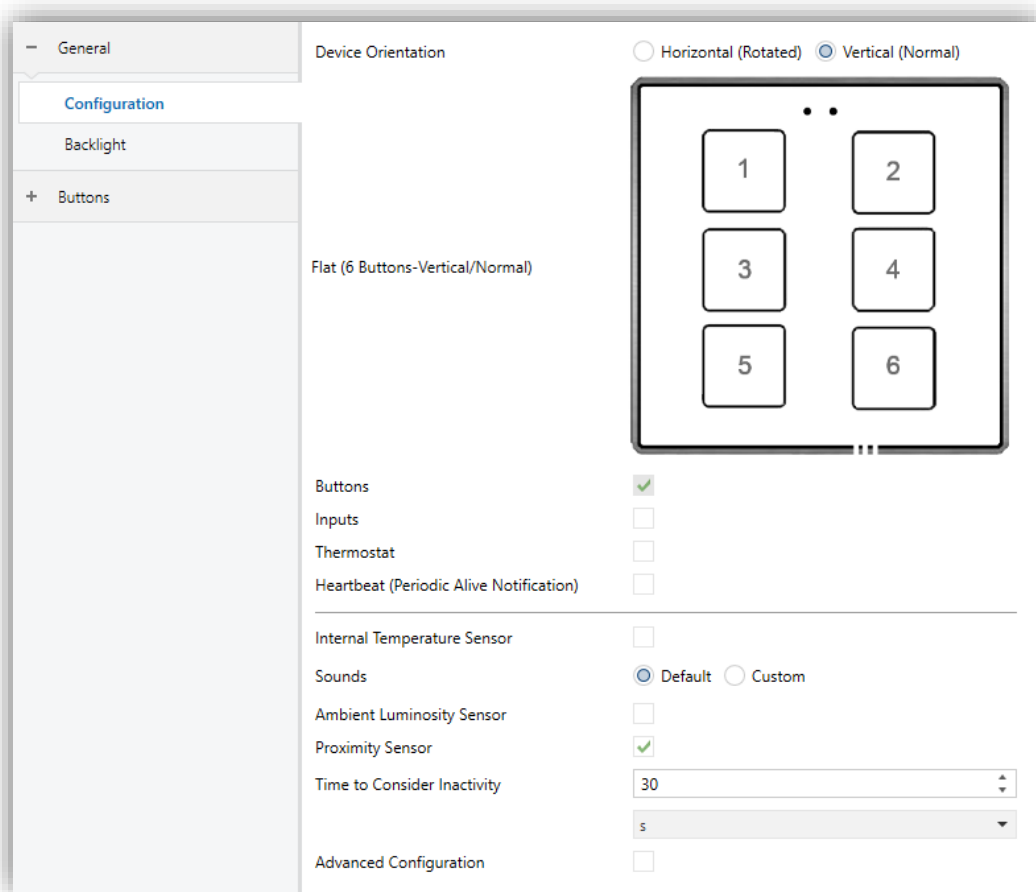

Figure 4 Main configuration.

- **Buttons** [[enabled](#)]: read-only parameter to make it evident that the “Buttons” tab is always enabled in the tab tree on the left. See section 2.2 for details.
- **Inputs** [[disabled/enabled](#)]: enables or disables the “Inputs” tab in the tree on the left, depending on whether the device will or will not be connected any external accessories. See section 2.3 for details.
- **Thermostat** [[disabled/enabled](#)]: enables or disables the “Thermostat” tab in the tree on the left. See section 2.4 for details.
- **Heartbeat (Periodic Alive Notification)** [[disabled/enabled](#)]: incorporates a one-bit object to the project (“**[Heartbeat] Object to Send ‘1’**”) that will be sent periodically with value “1” to notify that the device is still working (*still alive*).

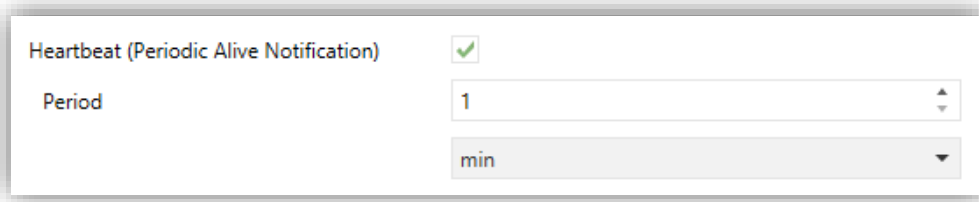

Figure 5. Heartbeat.

Note: the first sending after download or bus failure takes place with a delay of up to 255 seconds, to prevent bus overload. The following sendings march the period set.

- **Internal Temperature Sensor** (only in Flat vT) [[disabled/enabled](#)]: enables or disables the “Temperature Sensor” tab in the tree on the left. See section 2.1.2 for details.
- **Sounds** [[Default / Custom](#)]: sets whether the sound functions (button beeps, alarm and doorbell) should work according to the pre-defined configuration or to a user-defined configuration. See section 2.1.4 for details.
- **Ambient luminosity sensor** [[disabled/enabled](#)]: enables setting the ambient luminosity sensor. When the sensor is enabled, a new tab for its configuration is shown. See section 2.1.5 for details.
- **Proximity Sensor** [[disabled/enabled](#)]: enables the proximity sensor. This functionality permits “waking up” the device when detecting presence.

Please refer to the specific manual “**Proximity and Luminosity Sensor**” (available in the Flat vT / Flat 55 vT product section at the Zennio homepage, www.zennio.com) for detailed information about the functionality and the configuration of the related parameters.

- **Time to Consider Inactivity** [[1...30...255](#)][[s/min/h](#)]: allows setting a time after which, if no pulsation or proximity detection has occurred, the LEDs turn off (or acquire the brightness level configured, see section 2.1.3).
- **Advanced Configuration** [[disabled/enabled](#)]: enables or disables the “Advanced” tab in the tree on the left. See section 2.1.6 for details.

2.1.2 TEMPERATURE SENSOR

Note: *This functionality is only available in Flat vT.*

Flat vT is equipped with **one internal temperature probe** which can monitor the ambient temperature of the room, thus making the device capable of reporting it to the KNX bus and of triggering certain actions when the temperature reaches specific values.

Please refer to the specific manual “**Temperature Probe**” (available in the Flat vT product section at the Zennio homepage, www.zennio.com) for detailed information about the functionality and the configuration of the related parameters.

2.1.3 BACKLIGHT

Flat vT / Flat 55 vT allows managing the brightness of the LED according to two operating modes: normal mode and night mode.

Please refer to the specific manual “**Brightness**” (available in the Flat vT / Flat 55 vT product section at the Zennio website, www.zennio.com) for detailed information about the functionality and the configuration of the related parameters.

2.1.4 SOUNDS

It is possible to configure Flat vT / Flat 55 vT so that a brief beep is emitted as an **acoustic feedback when a button is pressed**.

Enabling the button sounds can be done either by parameters or through an object, being also possible to define in parameters if the button sounds should be initially enabled or not.

Moreover, Flat vT / Flat 55 vT can also emit the following sounds on request (through the corresponding communication objects) if enabled:

- **Doorbell sounds:** a single beep.
- **Alarm sounds:** a sequence of brief beeps with a higher pitch. The sequence will only stop when the alarm object gets deactivated or when the user touches any of the buttons (this, moreover the deactivation alarm, will trigger the button action).

The range of sounds emitted will be different depending on the sound type selected.

ETS PARAMETERISATION

In case the default button beep sound matches the requirements of the installation and the doorbell and alarm functions are not necessary, the **Sounds** parameter in the general “Configuration” tab (see section 2.1.1) can be set to “Default”. This will also imply that the button beeps will be unconditional, as it will not be possible to disable this function through an object.

On the other hand, if set to “Custom”, a specific tab named “Sounds” will show up in the tab tree on the left. The initial configuration of this screen is equivalent to the aforementioned default option. However, the following parameters will be configurable.

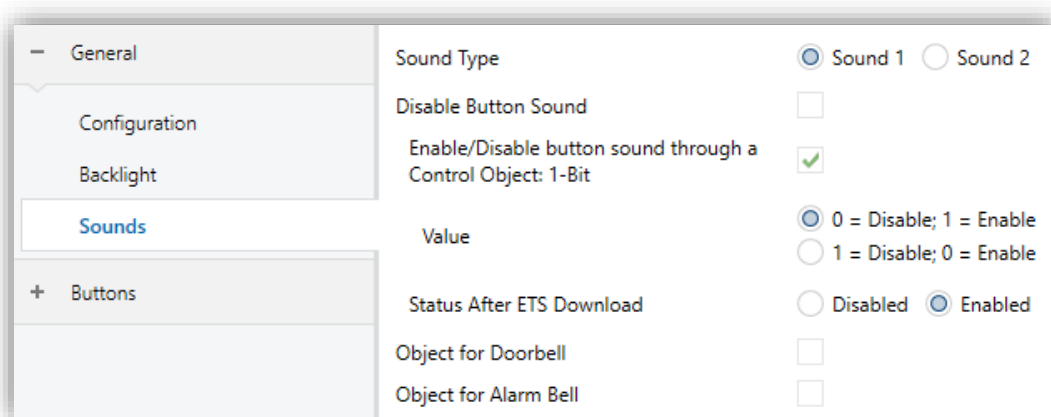

Figure 6. Sounds.

The default configuration of this tab is equivalent to the one mentioned above. However, the following parameters can be customized:

- **Sound Type** [[Sound 1](#) / [Sound 2](#)]: sets which sounds range incorporates the device.
- **Disable button sound** [[disabled/enabled](#)]: enables the buttons beeping. If enabled, the following parameters will also be available:
 - **Enable / Disable button sounds through a 1-bit object** [[disabled/enabled](#)]: makes it possible to disable / resume the button beeping function in runtime by writing to a specific object (“**[General] Sounds – Disabling button sound**”). If enabled, it will be shown:
 - **Value** [[0 = Disabled; 1 = Enabled](#) / [1 = Disabled; 0 = Enabled](#)]: allows configuring the values (0 or 1) that will disable/resume the sounds.

- **Status After ETS Download** [[enabled/disabled](#)]: sets whether the button beeping function should start up enabled or disabled after an ETS download.
- **Object for Doorbell** [[disabled/enabled](#)]: enables or disables the doorbell function. If enabled, a specific object (“**[General] Sounds - Doorbell**”) will be included into the project topology.
- **Object for Alarm Bell** [[disabled/enabled](#)]: enables or disables the alarm function. If enabled, a specific object (“**[General] Sounds - Alarm**”) will be included into the project topology.

2.1.5 AMBIENT LUMINOSITY SENSOR

Flat vT / Flat 55 vT incorporates a **luminosity sensor** to receive and monitor ambient brightness measurement.

Please refer to the specific manual “**Luminosity and Proximity Sensor**” (available in the Flat vT / Flat 55 vT product section at the Zennio homepage, www.zennio.com) for detailed information about the functionality and the configuration of the related parameters.

2.1.6 ADVANCED

Independent tab for the parameterisation of some advanced functions. These functions are explained next.

ETS PARAMETERISATION

After enabling the **Advanced configuration** from “Configuración” screen (see section 2.1.1), a new tab will be incorporated into the tree on the left.

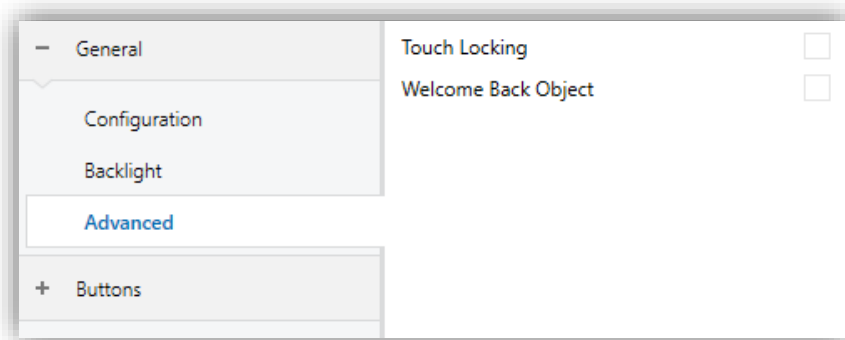

Figure 7. Advanced.

- **Touch locking** [[disabled/enabled](#)]: enables or disables the “Touch locking” tab in the tree on the left. See section 2.1.6.1 for details.
- **Welcome back object** [[disabled/enabled](#)]: enables or disables the “Welcome back” tab in the tree on the left. See section 2.1.6.2 for details.

2.1.6.1 TOUCH LOCKING

The touch panel of Flat vT / Flat 55 vT can be optionally locked and unlocked anytime by writing a configurable one-bit value to a specific object provided for this purpose. It can also be done through scene values.

While locked, pressing on the buttons will be ignored: no actions will be performed (and no LEDs will change their states) when the user touches on any of the controls.

ETS PARAMETERISATION

After enabling **Touch Locking** in “Advanced” tab, a new tab will be incorporated into the tree on the left.

Figure 8. Touch Locking: Control.

- **Control Object: 1-Bit** [[disabled/enabled](#)]: when marked, a specific drop-down list will show up to select which value should trigger which action.
 - **Value** [[0 = Unlock; 1 = Lock](#) / [0 = Lock; 1 = Unlock](#)]: these values are received through the object “[**General**] Touch Locking”.
- **Scene Object** [[disabled/enabled](#)]: when marked, two specific textboxes will show up to enter the scene numbers (1 - 64) that should trigger each action. These values are to be received through the general “[**General**] Scene: Receive” object.

2.1.6.2 WELCOME BACK OBJECT

Flat vT / Flat 55 vT can send a specific object (the *welcome back object*) to the KNX bus when the user presses a touch button after a significant amount of time since the last or presence detection (when the proximity sensor is enabled). Sending it or not can also depend on an **additional, configurable condition** consisting in the evaluation of up to five binary objects.

Any actions that in normal operation may be executed will not be if the welcome back object is sent to the bus. Thus, if the user presses a button and this causes that the welcome back object is sent, the normal action of that button will not be triggered.

On the other hand, if the additional condition is not evaluated to true, the device will react normally. Hence, the action corresponding to the button touch will be executed.

The welcome back object can consist in a **one-bit** value or a **scene** value (or both), depending on the parameterisation.

ETS PARAMETERISATION

After enabling **Welcome Back Object**, a new tab will be incorporated into the tree on the left.

Time to Activate the Welcome Object	1
	h
Sending Trigger	<input checked="" type="radio"/> Push Button <input type="radio"/> Proximity Detection
Additional Condition	No Additional Condition
Welcome Back Object (1-Bit)	<input type="checkbox"/>
Welcome Back Object (Scene)	<input type="checkbox"/>

Figure 9 Welcome Back Object.

This screen contains the following parameters:

- **Timeout to Activate the Welcome Object** [1...255][s/min/h]: sets the minimum time that should elapse after the last button touch touch (or presence detection, when the proximity sensor is enabled) before the next one triggers the execution of the welcome back function.

- **Sending Trigger** [[Push Button/Proximity Detection](#)]: sets whether the welcome back object is sending after a touch in the screen or when the proximity sensor detects presence.

- **Additional Condition**: sets if sending the welcome back object should also depend on an external condition. The option by default is “[[No Additional Condition](#)]. The following are available too:
 - [[Do not send unless all additional conditions are 0](#)]: the welcome back object will only be sent if all the condition objects are found to have the value “0”.
 - [[Do not send unless all additional conditions are 1](#)]: the welcome back object will only be sent if all the condition objects are found to have the value “1”.
 - [[Do not send unless at least one of the additional conditions is 0](#)]: the welcome back object will only be sent if at least one of the condition objects is found to have the value “0”.
 - [[Do not send unless at least one of the additional conditions is 1](#)]: the welcome back object will only be sent if at least one of the condition objects is found to have the value “1”.

- **Welcome Back Object (1-Bit)** [[disabled/enabled](#)]: checkbox to enable the sending of a 1-bit value (through “[**General**] Welcome back”) when the welcome back function is triggered and the condition (if any) evaluates to true. The desired value should set in **Value** [[Send 0 / Send 1](#)].

- **Welcome Back Object (Scene)** [[disabled/enabled](#)]: checkbox to enable the sending of a scene run request (through “[**General**] Scene: send”) when the welcome back function is triggered and the condition (if any) evaluates to true. The desired value should be set in **Scene Number** [[1...64](#)].

2.2 BUTTONS

Flat vT / Flat 55 vT has **two, four or six** (only in Flat vT) **capacitive buttons** (depending on the model) at the user's disposal for the execution of actions.

The distribution of the buttons will depend on the model, being possible to configure them as single-button controls or in pairs by **combining any two of them**.

There are some differences in the button configuration depending on the model:

- **Flat 2 vT / Flat 55 X2 vT:** up to two one-button controls can be configured, or either one two-button control, and under any of the two orientations for Flat 2 vT.

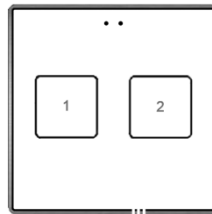

Figure 10 Flat 2 vT and Flat 55 X2 vT. Normal orientation.



Figura 11. Flat 2 vT. Rotated orientation.

- **Flat 4 vT / Flat 55 X4 vT** up to four one-button controls can be configured, or up to two two-button controls (by combining any two buttons for each pair). The figure shows which number identifies each button during the configuration process.

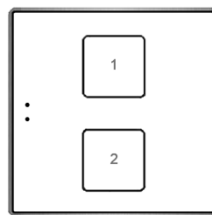
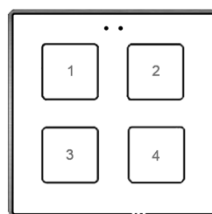

Figure 12 Flat 4 vT and Flat 55 X4 vT.

- **Flat 6 vT:** up to six one-button controls, or three two-button controls (by combining any two push buttons for each pair) can be configured, under any of

the two orientations. The figure shows which number identifies each button during the configuration process.

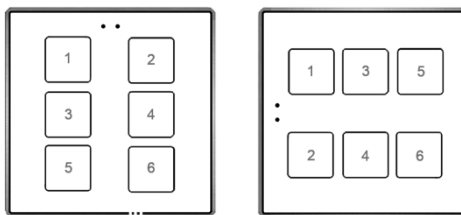

Figure 13 Flat 6 vT. Normal orientation (left) and rotated (right).

2.2.1 CONFIGURATION

The following is a list of the functions that can be assigned to each button.

- **Disabled** (the button will not react to user presses).
- **Pair A, B or C** (the number of available pairs depends on the selected model), being the function of such pair one of the following:
 - Switch (binary).
 - Light dimmer.
 - Two objects (short press / long press).
 - Shutter.
- **Individual** (one-button control):
 - Switch (Binary).
 - Counter constant.
 - Hold & release.
 - Float constant.
 - Two objects (short press / long press).
 - Light dimmer.
 - Shutter.
 - Scene.
 - LED indicator.
 - Scaling constant.
 - Room State

Apart from the button function itself, the desired behaviour of the button LEDs can be set. The different illumination modes have been detailed in [ANNEX I. LED Illumination Modes](#).

The next sections explain the configuration involved for each of the above functions.

ETS PARAMETERISATION

An independent tab for the parameterisation of the buttons is shown in ETS by default, initially containing only a sub-tab named “Configuration”.

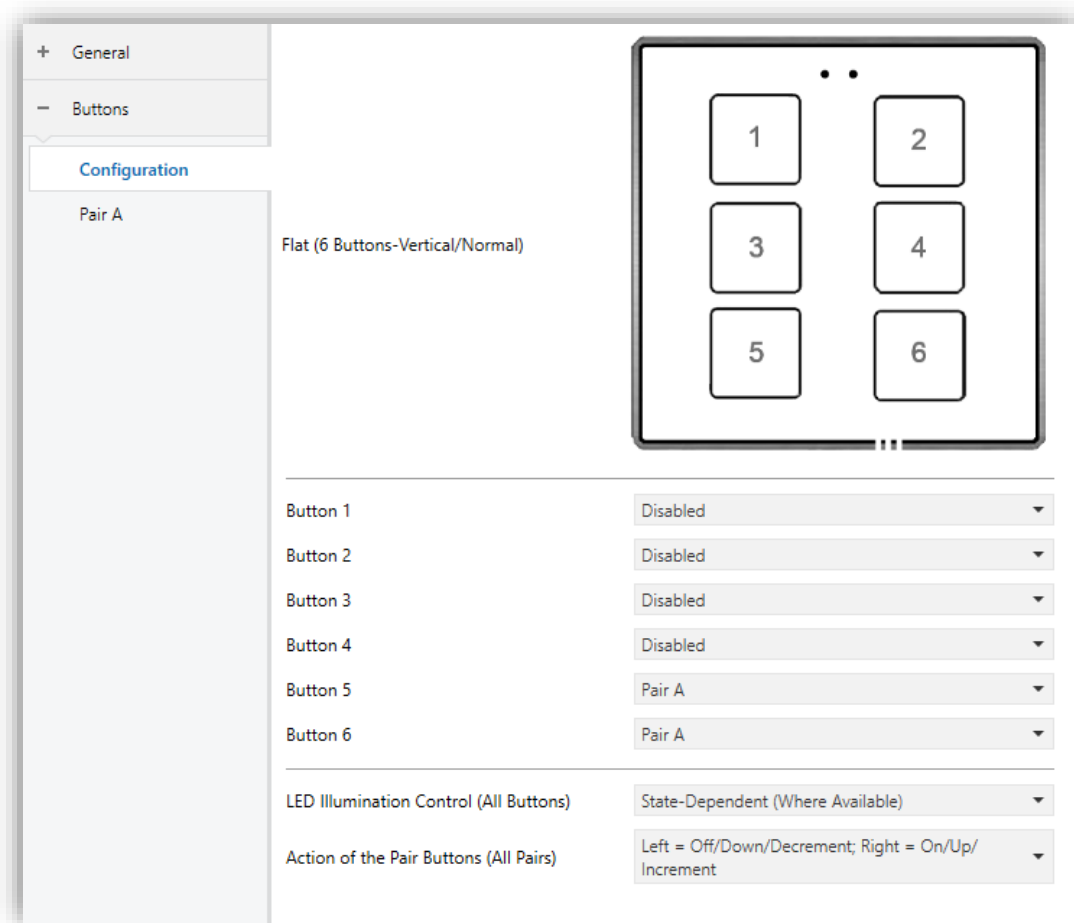

Figure 14 Buttons - Configuration

One drop-down list with the following options is shown per button:

- [\[Disabled\]](#). See section 2.2.2 for details.
- [\[Individual\]](#). Selecting this option brings a new tab (“**Button ix**”, where “x” depends on the button), which will make it possible to configure the functionality of that particular touch button. See section 2.2.3 for details.
- [\[Pair X\]](#). Sets that this touch button will belong to a two-button control (where X is A, B or C, depending on the model). Once one pair has been assigned to two buttons (and not before), a new tab (“**Pair X**”) will show up in the tab tree, in order to configure the desired functionality. See section 2.2.4 for details.

A drop-down list (**LED Illumination Control (All buttons)**) is provided at the bottom of the window so a joint behaviour can be configured for the illumination of the LEDs. The options are (please refer to ANNEX I. LED Illumination Modes for details):

- [Regular]
- [State-Dependent (where available)]
- [State-Dependent (where available) (both LEDs)]
- [Dedicated Object]
- [Configure every button (pair) separately]: in case of selecting the last option, there will be a specific parameter **for each control** to specifically select the desired behaviour of the LED (or LEDs).

Finally, if at least one two-button control is being configured (either Pair A or Pair B), an additional parameter (**Action of the pair buttons (all pairs)**) will be available to determine an operation criterion. The options are:

- [Left = Off/Down/Decrement; Right = On/Up Increment]
- [Right = Off/Down/Decrement; Left = On/Up Increment]
- [Every button pair is configured separately]

2.2.2 DISABLED

While a button stays disabled, it will not be functional: touching on it will not cause the execution of actions, nor will make the associated LED light.

ETS PARAMETERISATION

This function has no related parameters.

2.2.3 INDIVIDUAL

Buttons configured to work as individual (separate) controls can be assigned any of the following control functions:

- **LED indicator:** user presses will not trigger any function although the LED will turn on or off depending on the values received from the bus.
- **Switch:** whenever the user touches the button, a binary value will be sent to the KNX bus. This value is configurable and may be 0 or 1, or alternate with every touch according to the sequence $1 \rightarrow 0 \rightarrow 1 \rightarrow \dots$

Under a “State-dependent” LED illumination, the LED will remain on/off according to the current state (on/off) of the object.

- **Hold & Release:** as soon as the user touches the button, a binary value (“0” or “1”, configurable) will be sent to the KNX bus. And as long as the user releases the button, another value (“0” or “1”, also configurable) will be sent through the same object.

The “State-dependent” LED mode is not available for this function.

- **Two Objects (Short Press / Long Press):** specific binary values will be sent both after a short or a long press (a different object will be used in each case). Under a “State-dependent” LED illumination, the LED will remain on/off according to the current state (on/off) of either one object or the other, which can be configured in parameters. However, if **LED Illumination Control (All Buttons)** has been set to “State-dependent (where available)”, only the short press object will apply.
- **Scene:** after the user touches the button, an order to run a specific scene (configurable) will be sent to the bus. If enabled in parameters, orders to save

the scene can also be sent to the bus after a three-second press on the button. The “State-dependent” LED mode is not available for this function.

- **Scaling Constant:** sends a percentage value (configurable) to the bus when the user touches the button. Under a “State-dependent” LED illumination, the LED will remain on/off depending on whether the current value of the object matches the one parameterised. This object can also be written from the bus, which will update the LED according to the new value.
- **Counter Constant:** sends an integer value (configurable) to the bus when the user touches the button. This value can be one-byte or two-byte sized, as well as signed or unsigned. The available ranges are shown next:

	1-byte	2-byte
Unsigned	0 – 255.	0 – 65535.
Signed	-128 – 127.	-32768 – 32768.

Table 1 Value range – Counter type constant

The “State-dependent” LED illumination mode is analogous as for the Scaling Constant function.

- **Float Constant:** sends a two-byte floating point value (configurable) to the bus when the user touches the button. The available range is -671088.64 to 670433.28.

The “State-dependent” LED illumination mode is analogous as for the Scaling Constant and Counter Constant functions.

- **Dimmer:** implements a one-button light control that sends orders to the KNX bus, which can then be executed by light dimmers. These orders consist in:
 - Switch-on/Switch-off orders (on short presses).
 - Step dimming orders (on long presses) and the subsequent stop order once the button is released.

Being a one-button control, the **switch orders will alternate** (on/off) for every short press, and so will do the step dimming orders (increase/decrease) for every long press. However, there are some exceptions:

- On a long press: an increase dimming order will be sent if the light is found to be off (according to the status object). On the other hand, a decrease order will be sent if it is found to be 100%.
- On a short press: a switch-on order will be sent if the light is found to be off (according to the status object). On the other hand, a switch-off order will be sent if it is found to be on (value greater than 0%).

Note that the device considers that the **current light level** is the value of a specific one-byte object provided to be written from the KNX bus (i.e., to receive feedback from the dimmer). This object is internally updated after a short or long press, but linking it to the real dimmer status is highly advisable.

Under a “state-dependent” LED illumination, the LED will remain on/off according to the value of the aforementioned status object (i.e., off when the value is 0% and on in any other case).

Note: *after a bus recovery, the light dimmer should send back the status object so the control and the LED update their own state, instead of simply recovering the previous one.*

- **Shutter**: implements a one-button shutter control that sends orders to the KNX bus, which can then be executed by an actuator.

Two control types can be configured:

- Standard: the device will react to both long and short presses, being possible to send the bus the following commands:
 - Move (raise/lower) orders (on **long presses**).
 - Stop/Step orders (on **short presses**).

Being a one-button control, the direction of the motion will alternate (upwards/downwards) for both the move and the step orders after every long press. However, there are some exceptions to this alternation:

- On a short press: a step-up order will be sent if the last long press made the shutter move up, or if the current position is found to be 100%. On the other hand, a step-down order will be sent if the last long press made the shutter move down or if the current position is found to be 0%.

- On a long press: a move-up order will be sent if the last short press caused a step-down order or if the current position is found to be 100%. On the other hand, a move-down order will be sent if the last short press caused a step-up order or if the current position is found to be 0%.

As usual in the KNX standard, stop/step orders are interpreted by the actuators as a request to move the slats one step up or down (in case the shutter is still) or as a request to interrupt the motion of the shutter (in case it is already moving up or down).

Flat vT / Flat 55 vT are aware of the current position of the shutter through a specific object which should be linked to the analogous object of the shutter actuator in order to receive feedback.

- Hold & Release: the device will send an order to move the shutter when the button is touched, and the order to stop it as soon as it is released. Hence, short or long touches have the same effect: the shutter will remain in motion as long as the user keeps holding the button.

The direction of this motion (upwards or downwards) will **alternate** with every touch, according to the following sequence: downwards → upwards → downwards → ...

However, there are some exceptions to this alternation:

- If the position of the shutter is found to be 0%, the next order will lower the shutter.
- If the position of the shutter is found to be 100%, the next order will raise the shutter.

Flat vT / Flat 55 vT are aware of the current **position of the shutter** through a specific object which should be linked to the analogous object of the shutter actuator, in order to receive feedback.

This object is initialised with value “50%” after a download or a bus failure; therefore, the actuator is required to update it with the real value after the bus recovery.

The “state-dependent” LED illumination mode is not available for this function.

- **Room State:** allows controlling the room states (normal, make up request, do not disturb). Pressing the button will activate the *Do Not Disturb* or *Make-Up Request* status (as configured) or deactivate it to return to *Normal* status.

Depending on the parameterisation and the current value of object, after a short press the following values will be transmitted.

Parameterisation	Current Object Value	Transmitted Value
Make-Up Request	Do Not Disturb / Normal	Make-Up Request
	Make-Up Request	Normal
Do Not Disturb	Normal / Make-Up Request	Do Not Disturb
	Do Not Disturb	Normal

Table 2 Room States

If the LED illumination es “State-dependent”, LED will light up when the current object value coincides with the parameterized value.

ETS PARAMETERISATION

When an individual button has been enabled, a specific tab (“Button In”) becomes available under “Buttons” in the tree on the left.

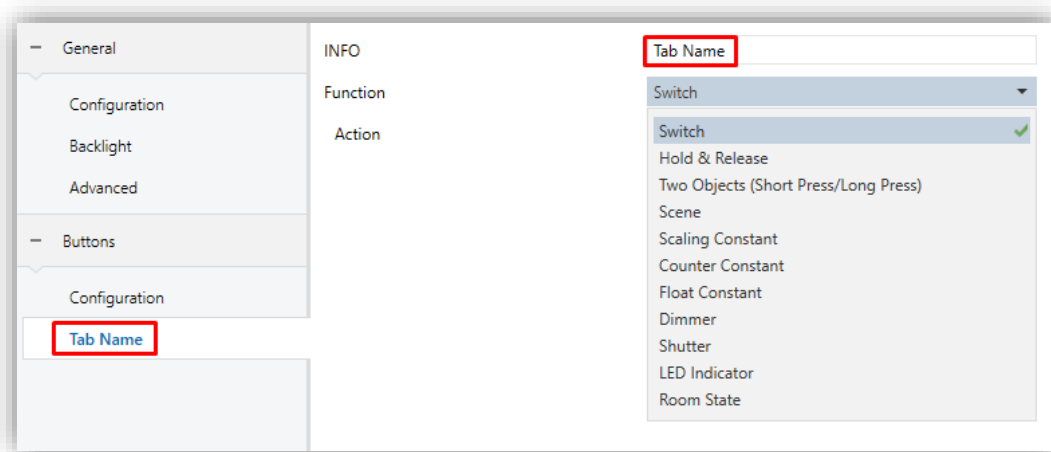

Figure 15 Individual Button.

Textbox **INFO** allows changing the default name of the tab in the left menu, as shows the following figure.

The main parameter that needs to be configured is:

- **Function** [[Switch](#) / [Hold & Release](#) / [Two Objects \(short press / long press\)](#) / [Scene](#) / [Scaling constant](#) / [Counter constant](#) / [Float constant](#) / [Dimmer](#) / [Shutter](#) / [LED indicator](#) / [Room State](#)]: sets the desired function for the button.

In case the option "[Configure every button \(pair\) separately](#)" has been selected in the **LED Illumination Control Parameter (All Buttons)** in the "Configuration" tab (see section 2.2.1), the additional parameter will be displayed:

- **LED Illumination Control** [[State-Dependent](#) / [Regular](#) / [Dedicated Object](#)].

In case of selecting the latter, the object "[Btn] [PX] Led On/Off" will be included in the project topology and a new parameter to select the **value** [[0 = Off; 1 = On](#) / [0 = On; 1 = Off](#)] to switch off and on the LED shows up:



Figura 16. Button Pair – LED Illumination – Dedicated Object

Note: For further information, please refer to section 2.2.1 and [ANNEX I. LED Illumination Modes](#).

Depending on the function, some more parameters are involved (as described next). Please note that in the next pages "[In]" is used as a general notation for the communication objects, where "n" depends on the particular button pair.

LED Indicator

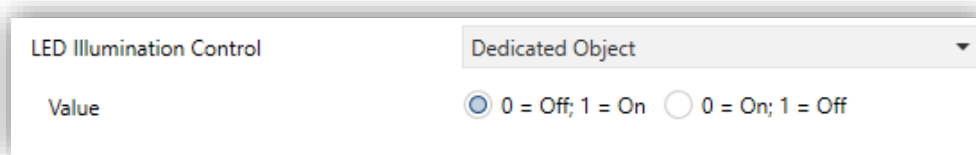
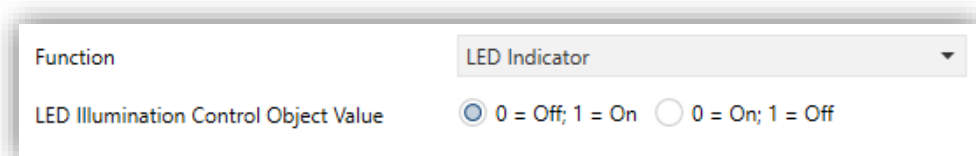

Figure 17 Individual Button – LED indicator.

- **LED illumination control object value** [[0 = Off; 1 = On](#) / [0 = On; 1 = Off](#)]: sets the behaviour of the LED of the button. The options are similar to those of the dedicated-object LED illumination available for other control types.

Note: *this parameter does not depend on the option selected for **LED Illumination Control (All Buttons)** (see section 2.2.1).*

After assigning this function to the button, object “[Btn] [In] LED On/Off” is included in the project topology, so that the values that determine the state of the LED at a given time can be received from the bus.

Switch

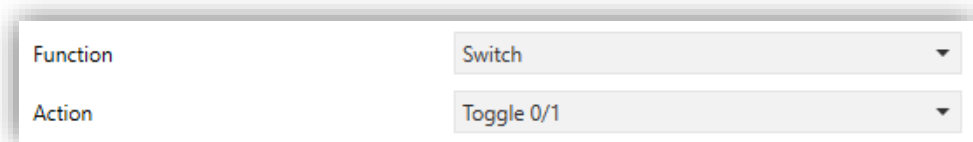

The screenshot shows a configuration window for a button. It has two rows: 'Function' and 'Action'. The 'Function' dropdown menu is set to 'Switch'. The 'Action' dropdown menu is set to 'Toggle 0/1'.

Figure 18 Individual Button - Switch.

- **Action** [[Toggle 0/1](#) / [Send 0](#) / [Send 1](#)]: sets the value to be sent to the bus (through object “[Btn] [In] Switch”) when the user touches the button.

Hold & Release

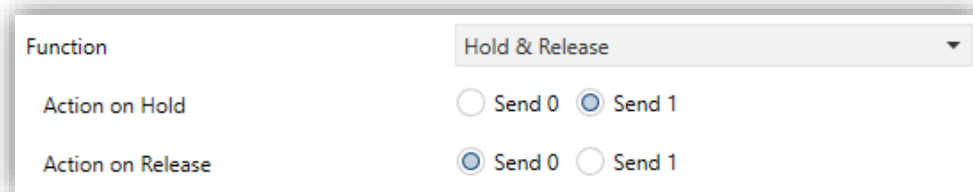

The screenshot shows a configuration window for a button. It has a 'Function' dropdown menu set to 'Hold & Release'. Below it are two rows of radio button options: 'Action on Hold' with 'Send 0' and 'Send 1' (selected), and 'Action on Release' with 'Send 0' (selected) and 'Send 1'.

Figure 19 Individual Button - Hold & Release.

- **Action on Hold** [[Send 1](#) / [Send 0](#)]: sets the value to be sent to the bus (through “[Btn] [In] Hold & Release”) when the user touches the button.
- **Action on Release** [[Send 0](#) / [Send 1](#)]: sets the value to be sent to the bus (again, through “[Btn] [In] Hold & Release”) when the user stops touching the button.

Two Objects (Short Press / Long Press)

The screenshot shows a configuration window with the following fields:

- Function:** Two Objects (Short Press/Long Press) (dropdown menu)
- Long Press Threshold Time:** 5 (input field) ds (unit)
- Action on Short Press:** Send 0 (dropdown menu)
- Action on Long Press:** Send 0 (dropdown menu)

Figure 20 Individual Button - Two Objects (Short Press / Long Press).

- **Long Press Threshold Time** [0...5...50 ds]: sets the minimum time the user should hold the button in order to consider it a long press.
- **Action on Short press** [[Send 0](#) / [Send 1](#) / [Toggle 0/1](#) / [Send 1-byte value](#)]: sets the value to be sent to the bus (through “[Btn] [In] Two switches - Short press”) when the user short-presses the button.

In case of selecting the latter, an additional parameter (**Value** [0...255]) will be displayed to enter the desired one-byte value.

- **Action on Long press** [[Send 0](#) / [Send 1](#) / [Toggle 0/1](#) / [Send 1-byte value](#)]: sets the value to be sent to the bus (through “[Btn] [In] Two switches - Long press”) when the user long-presses the button.

Scene

The screenshot shows a configuration window with the following fields:

- Function:** Scene (dropdown menu)
- Action:**
 - Run Scene
 - Run (Short Press) + Save (3s Press) Scene
- Scene Number:** 1 (input field)

Figure 21 Individual Button - Scene.

- **Action** [[Run scene](#) / [Run \(short press\) + Save \(3s press\) scene](#)]: sets whether the value to be sent to the KNX bus (through “[General] Scene: send”) when the user touches the button will always be a scene run request or –depending on the length of button press– a scene run or save request.
- **Scene number** [1...64]: number of the scene to be sent to the bus, both in the case of the run requests and the save requests.

Scaling Constant / Counter Constant / Float Constant

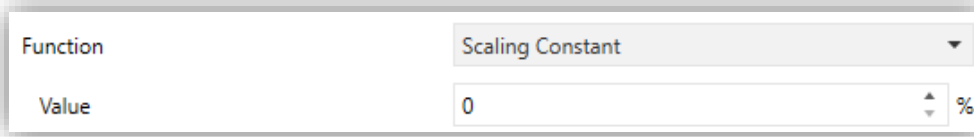

Figure 22 Individual Button - Scaling Constant

- **Value [0]:** sets the value to be sent to the KNX bus when the user touches the button. The available range and the object through which the value is sent depend for each case, as the table below shows.

In case of selecting Counter Constant, two specific parameters (“**Size**” and “**Signed**”) will be displayed to respectively define the size of the constant (“1 byte” or “2 bytes”) and whether it is a signed value or an unsigned value. Depending on that, the range and the name of the object will vary.

	Available Values	Name of the Object
Scaling Constant	0% – 100%	[Btn] [In] Scaling
Counter Constant	0 – 255	[Btn] [In] Counter – 1-Byte unsigned
	-128 – 127	[Btn] [In] Counter – 1-Byte Signed
	0 – 65535	[Btn] [In] Counter – 2-Byte Unsigned
	-32768 – 32767	[Btn] [In] Counter – 2-Byte Signed
Float Constant	-671088.64 – 670433.28	[Btn] [In] Float

Table 3 Constant type numerical control

Dimmer

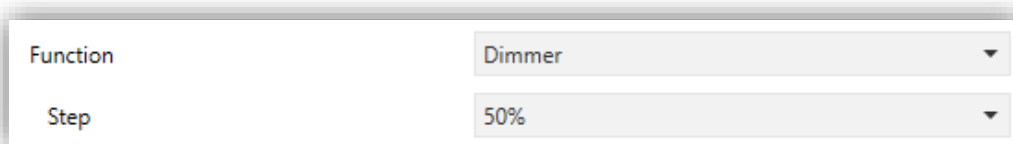

Figure 23 Individual Button - Dimmer

The (alternating) switch orders will be sent through the “[**Btn**] [**In**] **Light - On/Off**” one-bit object, while the (alternating) increase/decrease/stop orders will be through the “[**Btn**] [**In**] **Light - Dimming**” four-bit object.

On the other hand, the “[**Btn**] [**In**] **Light - Dimming (Status)**” one-byte object may be linked to the light level status object of the dimmer (in fact, this object is only intended to

receive values from the bus, not to send them). As explained at the beginning of this section, the state-dependent LED lighting will be determined by the value of this object (LED off at 0% and on at any other level).

The parameters for this function are:

- **Step** [[100%](#) / [50%](#) / [25%](#) / [12,5%](#) / [6,25%](#) / [3,1%](#) / [1,5%](#)]: defines the dimming step to be sent (through “[Btn] [In] Light - Dimming”) to the light dimmer with every long press.

Note: *since dimmers typically do not apply the new light level immediately (i.e., the step is performed progressively) and since Flat vT / Flat 55 vT send an order to interrupt the step dimming once the user releases the button, it is advisable to configure a step of 100%.*

This way, the user can perform any dimming step by simply leaving the button pressed and then releasing it, without needing to make successive button presses.

Shutter

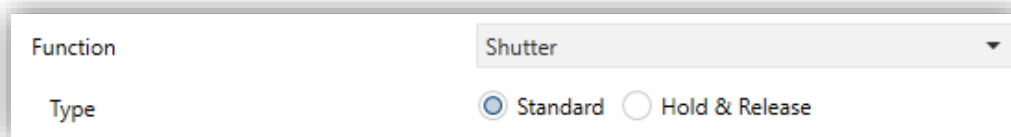

Figure 24 Individual Button - Shutter

The (alternating) move up/down orders will be sent through the “[Btn] [In] Shutter - Move” one-bit object, while the (alternating) step up/down orders will be through the “[Btn] [In] Shutter - Stop / Step” one-bit object.

Additionally, a one-byte object (“[Btn] [In] Shutter Position”) is provided to link it to the position status object of the shutter actuator (in fact, this object is only intended to receive values from the bus, not to send them).

The parameters for this function are:

- **Type** [[Standard](#) / [Hold & Release](#)]: sets the desired control type.

Room State

When this function is assigned to the button, the object for the control “[Btn][In] Room State” is enabled. This object will also be a status indicator.



Figura 25. Individual Button – Room state

- **State** [[Make-up Request](#) / [Do not Disturb](#)]: sets the state that is activated with this button. Commutes between Normal (“0”) and the selected state: Make-up room (“1”) and Do not disturb (“2”).

2.2.4 PAIR

Buttons configured to work as a joint control can be assigned the following functions:

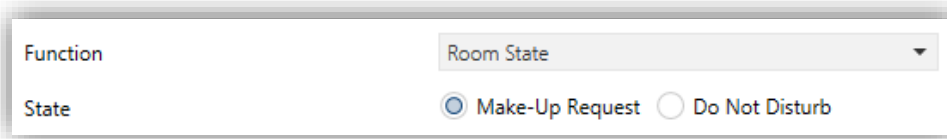
- **Switch:** pressing one of the two buttons will make Flat vT / Flat 55 vT send a binary value to the bus, while pressing on the other will make it send the inverse binary value. It is possible to configure which one does what.

Under a “state-dependent” LED illumination (see [ANNEX I. LED Illumination Modes](#)), the LED of the corresponding button will remain on/off according to the current state (on/off) of the switch. On the other hand, under a “state-dependent (both LEDs)” LED illumination, both of them will remain on while the switch is in the “on” state, and off while in the “off” state.

- **Two Objects (Short Press / Long Press):** permits sending specific binary values both after a short or a long press on any of the two buttons (i.e., they will work as a joint control; for independent buttons, please configure them as individual). Different objects will be used for the short and long presses.

Moreover, it is possible (in parameters) to make the “state-dependent” and “state-dependent (both LEDs)” LED illumination modes (see [ANNEX I. LED Illumination Modes](#)) depend on either one object or the other. However, if **LED Illumination Control (All Buttons)** has been set to “state-dependent (where available)” only the short press object will be considered

- **Dimmer:** short-pressing one of the two buttons will make Flat vT / Flat 55 vT send a switch-on order to the bus, while doing so on the other button will make it send a switch-off order.

Long presses will make it send a step dimming order (the value of which is configurable) to make a dimmer increase or decrease the light level (and a stop order as soon as the user releases the push button). It is possible to configure which button does what.

Under a “state-dependent” LED illumination (see [ANNEX I. LED Illumination Modes](#)), the LED of the corresponding button will remain on/off according to whether the current value of the light level status object (which should be updated by the actual dimmer) is greater than 0% or not. On the other hand, under a “state-dependent (both LEDs)” LED illumination, both together will remain on or off depending on such value.

- **Shutter:** this option permits making use of the two buttons to control a shutter actuator connected to the bus. Two alternative control methods are possible:
 - Standard: a long press will make the device send to the KNX bus an order to start moving the shutter (upwards or downwards, depending on the button), while a short press will make it send a stop order (which will be interpreted as an order to step up or to step down –depending on the button– if the shutter was not in motion and such function is available).
 - Hold & Release: as soon as the button is held, the device will send the KNX bus an order to start moving the shutter (upwards or downwards, depending on the button). Once the button is released, it will send an order to stop the shutter.

The “state-dependent” and “state-dependent (both LEDs)” LED illumination modes are not available for this function (only the “regular” and “dedicated object” LED illumination are available). See ANNEX I. LED Illumination Modes for details.

ETS PARAMETERISATION

Once two buttons have been assigned to a particular pair, a specific tab (“Pair X”) becomes available under “Buttons” in the tab tree.



Figure 26 Button Pair.

Textbox **INFO** allows changing the default name of the tab in the left menu, as shows the following figure.

The main parameter that needs to be configured is:

- **Function** [Switch / Two objects (short press / long press) / Dimmer / Shutter]: sets the desired function for the button pair.

In case the option "Configure every button (pair) separately" has been selected in the **LED Illumination Control Parameter (All Buttons)** in the "Configuration" tab (see section 2.2.1), the additional parameter will be displayed:

- **LED Illumination Control** [*State-Dependent / State-dependent (both LEDs) / Regular / Dedicated Object*].

In case of selecting the latter, the object "[Btn] [PX] Led On/Off" will be included in the project topology and a new parameter to select the **value** [0 = Off; 1 = On / 0 = On; 1 = Off] to switch off and on the LED shows up:



Figura 27. Button Pair – LED Illumination – Dedicated Object

Note: For further information, please refer to section 2.2.1 and ANNEX I. LED Illumination Modes.

Depending on the function, some more parameters are shown, as described next. Please note that in the next pages the general notation "[X]" is used for the name of the communication objects, as "X" depends on the button pair (A, B or C).

Switch

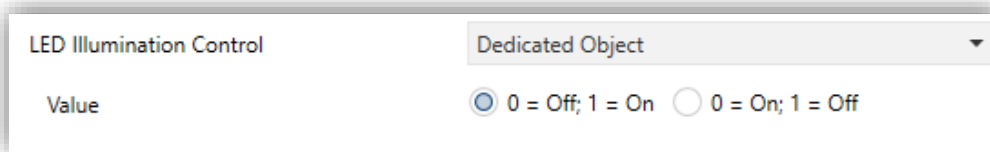
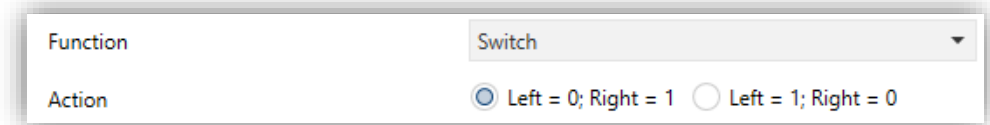

Figure 28 Pair Buttons – Switch.

- **Action** [Left=0; Right=1/Left=1; Right=0]: assigns each of the two buttons the value to be sent through "[Btn] [PX] Switch" (which has the Write flag enabled, so the state of the switch can be updated from external devices).

Note: this parameter will remain hidden unless having selected "Every button pair is configured separately" in **Action of the pair buttons**.

Two Objects (short Press / long press)

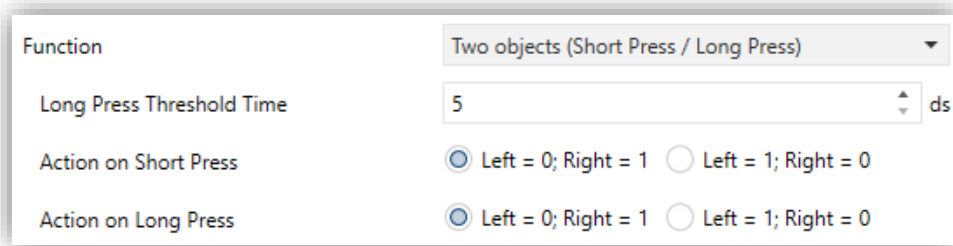

Figure 29 Pair Buttons - Two Objects (Short Press / Long Press).

- **Long Press Threshold Time** [5...50][ds]: sets the minimum time the user should hold the button in order to consider it a long press. The available range is 5 to 50 tenths of a second, being 5 tenths the default value.
- **Action on Short Press** [Left = 0; Right = 1 / Left = 1; Right = 0]: sets the value that will be sent through “[Btn] [PX] Two objects - Short press” after the user short-presses one of the two buttons.

Note: this parameter will remain hidden unless having selected “Every button pair is configured separately” in **Action of the pair buttons**.

- **Action on Long Press** [Left = 0; Right = 1 / Left = 1; Right = 0]: sets the value that will be sent through “[Btn] [PX] Two objects - Long press” after the user long-presses one of the two buttons.

Note: this parameter will remain hidden unless having selected “Every button pair is configured separately” in **Action of the pair buttons**.

Dimmer

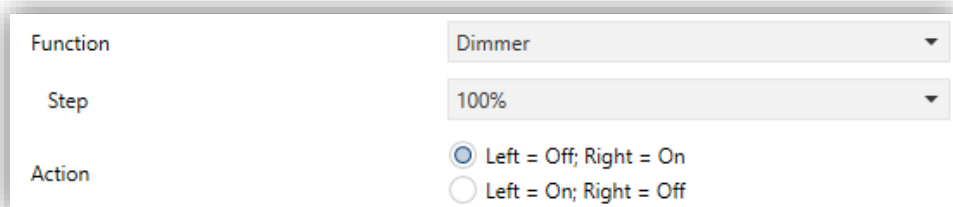

Figure 30 Pair Buttons - Dimmer.

The switch orders will be sent through the “[Btn] [PX] Light - On/Off” one-bit object, while the increase/decrease orders will be through the “[Btn] [PX] Light - Dimming” four-bit object.

On the other hand, the “[Btn] [PX] Light - Dimming (Status)” one-byte object may be linked to the light level status object of the dimmer (in fact, this object is only intended to receive values from the bus, not to send them).

The parameters for this function are:

- **Step** [[100%](#) / [50%](#) / [25%](#) / [12,5%](#) / [6,25%](#) / [3,1%](#) / [1,5%](#)]: defines the dimming step to be sent to the light dimmer with every increase / decrease order.

Note: *since dimmers typically do not apply the new light level immediately (i.e., the step regulation is performed progressively) and since Flat vT / Flat 55 vT send an order to interrupt the step dimming once the user releases the button, it is advisable to configure a step of 100%. This way, the user can perform any dimming step by simply leaving the button pressed and then releasing it without needing to make successive button presses.*

- **Action** [[Left = Off; Right = On](#) / [Left = On; Right = Off](#)]: assigns each of the two buttons the order to be sent.

Note: *this parameter will remain hidden unless having selected “Every button pair is configured separately” in Action of the pair buttons.*

Shutter

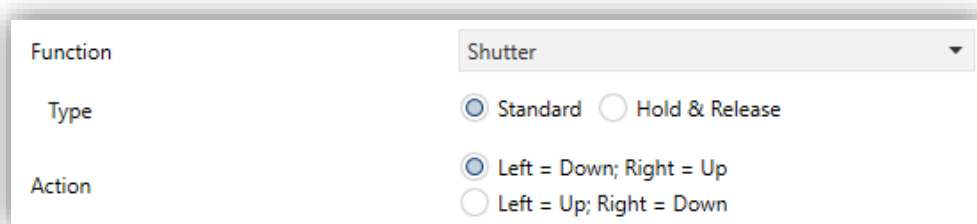

Figure 31 Pair Buttons - Shutter.

The move orders will be sent through “[Btn] [PX] Shutter - Move”, while the stop orders will be sent through “[Btn] [X] Shutter Stop/Step” (for Standard type) or “[Btn] [PX] Shutter - Stop” (for Hold & Release type).

The parameters for this function are:

- **Type** [[Standard](#) / [Hold & Release](#)]: sets the desired behaviour of the buttons.
- **Action** [[Left = Down; Right = Up](#) / [Left = Up; Right = Down](#)]: assigns each of the two buttons the order to be sent.

Note: *this parameter will remain hidden unless having selected “[Every button pair is configured separately](#)” in **Action of the pair buttons**.*

2.3 INPUTS

Flat vT / Flat 55 vT incorporates **two analogue/digital inputs**, each configurable as a:

- **Binary Input**, for the connection of a pushbutton or a switch/sensor.
- **Temperature Probe**, to connect a temperature from Zennio.
- **Motion Detector**, to connect a motion detector (suitable for the new motion detector model from Zennio).

2.3.1 BINARY INPUT

Please refer to the specific user manual “**Binary Inputs**”, available in the Flat vT / Flat 55 vT product section, at the Zennio website (www.zennio.com).

2.3.2 TEMPERATURE PROBE

Please refer to the specific user manual “**Temperature Probe**”, available in the Flat vT / Flat 55 vT product section, at the Zennio website (www.zennio.com).

2.3.3 MOTION DETECTOR

It is possible to connect motion detectors to the input ports of Flat vT / Flat 55 vT.

Please refer to the specific user manual “**Motion Detector**”, available in the Flat vT / Flat 55 vT product section, at the Zennio website (www.zennio.com).

2.4 THERMOSTAT

Flat vT / Flat 55 vT implements **one Zennio thermostat** which can be enabled and fully customised.

Please refer to the specific manual “**Zennio Thermostat**” (available in the Flat vT / Flat 55 vT product section at the Zennio website, www.zennio.com) for detailed information about the functionality and the configuration of the related parameters.

ANNEX I. LED ILLUMINATION MODES

The LED backlight of every button, by default (in most functions), will turn on for a brief instant whenever the button is touched. This behaviour is referred to as the “**Regular Illumination**”.

However, in most cases it is possible to assign different behaviours to the LEDs. Which options are available will depend on the function parameterised for the button, but will always include some of the following:

- **Regular Illumination:** the LED will light for an instant once the button is touched.
- **State-Dependent Illumination:** the LED will or will not light, depending on the value of the communication object that corresponds to the function implemented by the button. The exact correspondence between the different values of the object and the different states of the LED may be slightly different from one type of control to another, and is detailed for each function.
- **State-Dependent Illumination (both LEDs):** only applies to buttons configured as pair controls. The two LEDs of the control will light or not, depending on the value of the related object and on the particular control type parameterised for that pair of buttons. The only difference compared to the previous case is that, under “both LEDs”, the two LEDs will always turn off or on simultaneously, as if it were a unique indicator consisting of two LEDs.
- **Dedicated Object:** the LED will light or not depending on the value (“0” or “1”, configurable) of a binary, independent object. In the case of the pair controls, the value “0” will make one of the LEDs light (leaving the other one off), while the value “1” will make them switch their states.

Table 4 illustrates which of the above are configurable for each function.

		Disabled	Regular	State-dep.	State-dep. (both LEDs)	Dedicated object
PAIR	Switch		✓	✓	✓	✓
	Two Objects		✓	✓	✓	✓
	Dimmer		✓	✓	✓	✓
	Shutter		✓			✓
INDIVIDUAL	Switch		✓	✓		✓
	Hold & Release		✓			✓
	Two Objects		✓	✓		✓
	Scene		✓			✓
	Constants		✓	✓		✓
	Dimmer		✓	✓		✓
	Shutter		✓			✓
	LED Indicator					✓
	Room State		✓	✓		✓
DISABLED		✓				

Table 4 Functions vs. LED Illumination Options.

Note:

Regarding the LEDs, it is interesting to distinguish the following cases:

- Disabled button: the LED will remain off, and the button will have no function.
- Button configured as “Individual” with “LED Indicator” function: the button will still have no function. The LED may be turned on/off through a binary object.
- Button configured as any other control type: the behaviour of the LED will be configurable according to the following table (being also possible to leave it turned off).

Although the behaviour of the LEDs can be configured independently for each control, it is also possible to define a **general behaviour for all of them** thus not being then necessary to configure the same option multiple times.

In case of opting for a general configuration, the options are:

- **Regular.**
- **State-Dependent (where available).** Functions where “state-dependent” is not available will use the regular illumination.
- **State-Dependent (where available) (both LEDs).** Functions where “state-dependent” is not available will use the regular illumination.
- **Dedicated Object.** One binary communication object per control will be included in the project topology so that the LED of every control turns on/off depending on its own object.

ETS PARAMETERISATION

For details on the parameterisation of the LED illumination modes please refer to the pages that cover the specific function being assigned to the button (see section 2.2).

In case of desiring a **similar behaviour for all of the LEDs**, please find the parameter **LED Illumination Control (All buttons)** in the options of the “General” configuration.

ANNEX II. COMMUNICATION OBJECTS

- “Functional range” shows the values that, with independence of any other values permitted by the bus according to the object size, may be of any use or have a particular meaning because of the specifications or restrictions from both the KNX standard or the application program itself.

Note:

- The objects shown in this table are from model **Flat 6 vT**. Please note that certain objects will not be available in models with less push buttons.
- **Flat 55 vT** does not incorporate the internal temperature probe, nor the 6-button model, so objects applicable to these characteristics will not be available.

Number	Size	I/O	Flags	Data type (DPT)	Functional Range	Name	Function
1	1 Bit		C - - T -	DPT_Trigger	0/1	[Heartbeat] Object to Send '1'	Sending of '1' Periodically
2	1 Byte	I	C - W - -	DPT_SceneNumber	0 - 63	[General] Scene: Receive	0 - 63 (Run Scene 1-64)
3	1 Byte		C - - T -	DPT_SceneControl	0-63; 128-191	[General] Scene: Send	0 - 63/128 - 191 (Run/Save Scene 1-64)
4	1 Bit	I	C - W - -	DPT_Enable	0/1	[General] Touch Locking	0 = Unlock; 1 = Lock
	1 Bit	I	C - W - -	DPT_Enable	0/1	[General] Touch Locking	0 = Lock; 1 = Unlock
5	1 Bit		C - - T -	DPT_Switch	0/1	[General] Welcome Back Object	Switch Object Sent on Wake Up
6	1 Bit	I	C - W - -	DPT_Enable	0/1	[General] Sounds - Disabling Button Sound	0 = Disable Sound; 1 = Enable Sound
	1 Bit	I	C - W - -	DPT_Enable	0/1	[General] Sounds - Disabling Button Sound	0 = Enable Sound; 1 = Disable Sound
7	1 Bit	I	C - W - -	DPT_Ack	0/1	[General] Sounds - Doorbell	1 = Play a Doorbell Sound; 0 = Nothing
	1 Bit	I	C - W - -	DPT_Ack	0/1	[General] Sounds - Doorbell	0 = Play a Doorbell Sound; 1 = Nothing
8	1 Bit	I	C - W - -	DPT_Alarm	0/1	[General] Sounds - Alarm	1 = Play Alarm Intermittent Sounds; 0 = Stop Alarm Sounds
	1 Bit	I	C - W - -	DPT_Alarm	0/1	[General] Sounds - Alarm	0 = Play Alarm Intermittent Sounds; 1 = Stop Alarm Sounds
9, 10, 11, 12, 13	1 Bit	I	C - W - -	DPT_Switch	0/1	[General] Welcome Back Object - Additional Condition	Additional Condition Object x
14	1 Bit	I	C - W - -	DPT_Enable	0/1	[General] Proximity Sensor	0 = Disable; 1 = Enable
15	1 Bit	I	C - W - -	DPT_Ack	0/1	[General] External Proximity Detection	1 = Detection
16	1 Bit		C - - T -	DPT_Ack	0/1	[General] Proximity Detection	Send 1 when Proximity is Detected
17	1 Bit		C - - T -	DPT_Bool	0/1	[General] Luminosity (1-Bit)	0 = Over Threshold; 1 = Under Threshold
	1 Bit		C - - T -	DPT_Bool	0/1	[General] Luminosity (1-Bit)	0 = Under Threshold; 1 = Over Threshold
18	1 Byte	O	C R - - -	DPT_Scaling	0% - 100%	[General] Luminosity (Percentage)	0% ... 100%
20	1 Bit	I	C - W - -	DPT_DayNight	0/1	[General] Backlight Mode	0 = Night Mode; 1 = Normal Mode

	1 Bit	I	C - W - -	DPT_DayNight	0/1	[General] Backlight Mode	0 = Normal Mode; 1 = Night Mode
23, 29, 35, 41, 47, 53	1 Bit	I	C - W T -	DPT_Switch	0/1	[Btn][Ix] Switch	Send Selected Value on Short Press
	1 Bit	I	C - W T -	DPT_Switch	0/1	[Btn][Ix] Hold & Release	Send Selected Values on Hold and Release Presses
	1 Bit	I	C - W T -	DPT_Switch	0/1	[Btn][Ix] Two Objects - Short Press	Send Selected Value on Short Press
	1 Bit		C - - T -	DPT_Switch	0/1	[Btn][Ix] Light - On/Off	(Short Press) Switch Between On and Off
	1 Bit		C - - T -	DPT_Step	0/1	[Btn][Ix] Shutter - Stop/Step	(Short Press) 0 = Stop Shutter/Step Up; 1 = Stop Shutter/Step Down
	1 Bit		C - - T -	DPT_Trigger	0/1	[Btn][Ix] Shutter - Stop	(End Pressing) Stop Shutter
24, 30, 36, 42, 48, 54	4 Bit	I	C - W T -	DPT_Control_Dimming	0x0 (Stop) 0x1 (Dec. by 100%) ... 0x7 (Dec. by 1%) 0x8 (Stop) 0xD (Inc. by 100%) ... 0xF (Inc. by 1%)	[Btn][Ix] Light - Dimming	(Long Press) Switch Between Dimming Up and Down
25, 31, 37, 43, 49, 55	1 Bit		C - - T -	DPT_UpDown	0/1	[Btn][Ix] Shutter - Move	(Long Press) 0 = Up ; 1 = Down
	1 Bit		C - - T -	DPT_UpDown	0/1	[Btn][Ix] Shutter - Move	(Start Pressing) Switch Between Up and Down
	1 Bit	I	C - W T -	DPT_Switch	0/1	[Btn][Ix] Two Objects - Long Press	Send Selected Value on Long Press
26, 32, 38, 44, 50, 56	1 Bit	I	C - W T -	DPT_Switch	0/1	[Btn][Ix] LED On/Off	0 = Off; 1 = On
	1 Bit	I	C - W T -	DPT_Switch	0/1	[Btn][Ix] LED On/Off	0 = On; 1 = Off
	1 Byte	I	C - W T -	DPT_Scaling	0% - 100%	[Btn][Ix] Scaling	Send Selected Percentage Value on Short Press
27, 33, 39, 45, 51, 57	1 Byte	I	C - W T -	DPT_Value_1_Ucount	0 - 255	[Btn][Ix] Counter - 1-Byte Unsigned	Send Selected Value on Short Press
	1 Byte	I	C - W T -	DPT_Value_1_Count	-128 - 127	[Btn][Ix] Counter - 1-Byte Signed	Send Selected Value on Short Press
	2 Bytes	I	C - W T -	DPT_Value_2_Ucount	0 - 65535	[Btn][Ix] Counter - 2-Byte Unsigned	Send Selected Value on Short Press
	2 Bytes	I	C - W T -	DPT_Value_2_Count	-32768 - 32767	[Btn][Ix] Counter - 2-Byte Signed	Send Selected Value on Short Press
	2 Bytes	I	C - W T -	9.xxx	-671088.64 - 670433.28	[Btn][Ix] Float	Send Selected Value on Short Press
	1 Byte	I	C - W T -	DPT_Value_1_Ucount	0 - 255	[Btn][Ix] Two Objects - Short Press (1-Byte)	Send Selected 1-Byte Value on Short Press
	1 Byte	I	C - W T -	DPT_Scaling	0% - 100%	[Btn][Ix] Shutter - Position	0 - 100 %
	1 Byte	I	C - W T -	DPT_Scaling	0% - 100%	[Btn][Ix] Light - Dimming (Status)	0 - 100 %
	1 Byte	I	C - W T -	DPT_Room_State	0 - 255	[Btn][Ix] Room State	0 = Normal; 1 = Make-up Room; 2 = Do not Disturb
	28, 34, 40, 46, 52, 58	1 Byte	I	C - W T -	DPT_Value_1_Ucount	0 - 255	[Btn][Ix] Two Objects - Long Press (1-Byte)
83, 89, 95	1 Bit	I	C - W T -	DPT_Switch	0/1	[Btn][Px] Switch	Left = 0; Right = 1
	1 Bit	I	C - W T -	DPT_Switch	0/1	[Btn][Px] Two Objects - Short Press	Left = 1; Right = 0
	1 Bit	I	C - W T -	DPT_Switch	0/1	[Btn][Px] Two Objects - Short Press	Left = 0; Right = 1
	1 Bit		C - - T -	DPT_Switch	0/1	[Btn][Px] Light - On/Off	(Short Press) Left = Off; Right = On
	1 Bit		C - - T -	DPT_Step	0/1	[Btn][Px] Shutter - Stop/Step	(Short Press) Left = Stop/Step Down; Right = Stop/Step Up

	1 Bit		C--T-	DPT_Trigger	0/1	[Btn][Px] Shutter - Stop	(End Pressing) Left = Stop-Down; Right = Stop-Up
	1 Bit	I	C-WT-	DPT_Switch	0/1	[Btn][Px] Switch	Left = 1; Right = 0
	1 Bit		C--T-	DPT_Switch	0/1	[Btn][Px] Light - On/Off	(Short Press) Left = On; Right = Off
	1 Bit		C--T-	DPT_Step	0/1	[Btn][Px] Shutter - Stop/Step	(Short Press) Left = Stop/Step Up; Right = Stop/Step Down
	1 Bit		C--T-	DPT_Trigger	0/1	[Btn][Px] Shutter - Stop	(End Pressing) Left = Stop-Up; Right = Stop-Down
	1 Bit	I	C-WT-	DPT_Switch	0/1	[Btn][Px] Switch	Lower = 0; Upper = 1
	1 Bit	I	C-WT-	DPT_Switch	0/1	[Btn][Px] Switch	Lower = 1; Upper = 0
	1 Bit		C--T-	DPT_Switch	0/1	[Btn][Px] Light - On/Off	(Short Press) Lower = Off; Upper = On
	1 Bit		C--T-	DPT_Switch	0/1	[Btn][Px] Light - On/Off	(Short Press) Lower = On; Upper = Off
	1 Bit		C--T-	DPT_Step	0/1	[Btn][Px] Shutter - Stop/Step	(Short Press) Lower = Stop/Step Down; Upper = Stop/Step Up
	1 Bit		C--T-	DPT_Step	0/1	[Btn][Px] Shutter - Stop/Step	(Short Press) Lower = Stop/Step Up; Upper = Stop/Step Down
	1 Bit		C--T-	DPT_Trigger	0/1	[Btn][Px] Shutter - Stop	(End Pressing) Lower = Stop-Down; Upper = Stop-Up
	1 Bit		C--T-	DPT_Trigger	0/1	[Btn][Px] Shutter - Stop	(End Pressing) Lower = Stop-Up; Upper = Stop-Down
	1 Bit	I	C-WT-	DPT_Switch	0/1	[Btn][Px] Two Objects - Short Press	Lower = 0; Upper = 1
	1 Bit	I	C-WT-	DPT_Switch	0/1	[Btn][Px] Two Objects - Short Press	Lower = 1; Upper = 0
84, 90, 96	4 Bit	I	C-WT-	DPT_Control_Dimming	0x0 (Stop) 0x1 (Dec. by 100%) ... 0x7 (Dec. by 1%) 0x8 (Stop) 0xD (Inc. by 100%) ... 0xF (Inc. by 1%)	[Btn][Px] Light - Dimming	(Long Press) Left = Darker; Right = Brighter
	4 Bit	I	C-WT-	DPT_Control_Dimming	0x0 (Stop) 0x1 (Dec. by 100%) ... 0x7 (Dec. by 1%) 0x8 (Stop) 0xD (Inc. by 100%) ... 0xF (Inc. by 1%)	[Btn][Px] Light - Dimming	(Long Press) Left = Brighter; Right = Darker
	4 Bit	I	C-WT-	DPT_Control_Dimming	0x0 (Stop) 0x1 (Dec. by 100%) ... 0x7 (Dec. by 1%) 0x8 (Stop) 0xD (Inc. by 100%) ... 0xF (Inc. by 1%)	[Btn][Px] Light - Dimming	(Long Press) Lower = Darker; Upper = Brighter

	4 Bit	I	C - W T -	DPT_Control_Dimming	0x0 (Stop) 0x1 (Dec. by 100%) ... 0x7 (Dec. by 1%) 0x8 (Stop) 0xD (Inc. by 100%) ... 0xF (Inc. by 1%)	[Btn][Px] Light - Dimming	(Long Press) Lower = Brighter; Upper = Darker
85, 91, 97	1 Bit	I	C - W T -	DPT_Switch	0/1	[Btn][Px] Two Objects - Long Press	Left = 0; Right = 1
	1 Bit	I	C - W T -	DPT_Switch	0/1	[Btn][Px] Two Objects - Long Press	Left = 1; Right = 0
	1 Bit		C - - T -	DPT_UpDown	0/1	[Btn][Px] Shutter - Move	(Long Press) Left = Down; Right = Up
	1 Bit		C - - T -	DPT_UpDown	0/1	[Btn][Px] Shutter - Move	(Start Pressing) Left = Down; Right = Up
	1 Bit		C - - T -	DPT_UpDown	0/1	[Btn][Px] Shutter - Move	(Long Press) Left = Up; Right = Down
	1 Bit		C - - T -	DPT_UpDown	0/1	[Btn][Px] Shutter - Move	(Start Pressing) Left = Up; Right = Down
	1 Bit		C - - T -	DPT_UpDown	0/1	[Btn][Px] Shutter - Move	(Long Press) Lower = Down; Upper = Up
	1 Bit		C - - T -	DPT_UpDown	0/1	[Btn][Px] Shutter - Move	(Long Press) Lower = Up; Upper = Down
	1 Bit		C - - T -	DPT_UpDown	0/1	[Btn][Px] Shutter - Move	(Start Pressing) Lower = Down; Upper = Up
	1 Bit		C - - T -	DPT_UpDown	0/1	[Btn][Px] Shutter - Move	(Start Pressing) Lower = Up; Upper = Down
	1 Bit	I	C - W T -	DPT_Switch	0/1	[Btn][Px] Two Objects - Long Press	Lower = 0; Upper = 1
1 Bit	I	C - W T -	DPT_Switch	0/1	[Btn][Px] Two Objects - Long Press	Lower = 1; Upper = 0	
86, 92, 98	1 Bit	I	C - W T -	DPT_Switch	0/1	[Btn][Px] LED On/Off	0 = On; 1 = Off
	1 Bit	I	C - W T -	DPT_Switch	0/1	[Btn][Px] LED On/Off	0 = Off; 1 = On
87, 93, 99	1 Byte	I	C - W T -	DPT_Scaling	0% - 100%	[Btn][Px] Light - Dimming (Status)	0 - 100 %
113	1 Byte	I	C - W - -	DPT_SceneControl	0-63; 128-191	[Thermostat] Scene Input	Scene Value
114, 115	2 Bytes	I	C - W - -	DPT_Value_Temp	-273.00° - 670433.28°	[Tx] Temperature Source x	External Sensor Temperature
116	2 Bytes	O	C R - T -	DPT_Value_Temp	-273.00° - 670433.28°	[Tx] Effective Temperature	Effective Control Temperature
117	1 Byte	I	C - W - -	DPT_HVACMode	1=Comfort 2=Standby 3=Economy 4=Building Protection	[Tx] Special Mode	1-Byte HVAC Mode
118	1 Bit	I	C - W - -	DPT_Ack	0/1	[Tx] Special Mode: Comfort	0 = Nothing; 1 = Trigger
	1 Bit	I	C - W - -	DPT_Switch	0/1	[Tx] Special Mode: Comfort	0 = Off; 1 = On
119	1 Bit	I	C - W - -	DPT_Ack	0/1	[Tx] Special Mode: Standby	0 = Nothing; 1 = Trigger
	1 Bit	I	C - W - -	DPT_Switch	0/1	[Tx] Special Mode: Standby	0 = Off; 1 = On
120	1 Bit	I	C - W - -	DPT_Ack	0/1	[Tx] Special Mode: Economy	0 = Nothing; 1 = Trigger
	1 Bit	I	C - W - -	DPT_Switch	0/1	[Tx] Special Mode: Economy	0 = Off; 1 = On
121	1 Bit	I	C - W - -	DPT_Ack	0/1	[Tx] Special Mode: Protection	0 = Nothing; 1 = Trigger
	1 Bit	I	C - W - -	DPT_Switch	0/1	[Tx] Special Mode: Protection	0 = Off; 1 = On
122	1 Bit	I	C - W - -	DPT_Window_Door	0/1	[Tx] Window Status (Input)	0 = Closed; 1 = Open
123	1 Bit	I	C - W - -	DPT_Trigger	0/1	[Tx] Comfort Prolongation	0 = Nothing; 1 = Timed Comfort

124	1 Byte	O	CR-T-	DPT_HVACMode	1=Comfort 2=Standby 3=Economy 4=Building Protection	[Tx] Special Mode Status	1-Byte HVAC Mode
125	2 Bytes	I	C-W--	DPT_Value_Temp	-273.00° - 670433.28°	[Tx] Setpoint	Thermostat Setpoint Input
	2 Bytes	I	C-W--	DPT_Value_Temp	-273.00° - 670433.28°	[Tx] Basic Setpoint	Reference Setpoint
126	1 Bit	I	C-W--	DPT_Step	0/1	[Tx] Setpoint Step	0 = Decrease Setpoint; 1 = Increase Setpoint
127	2 Bytes	I	C-W--	DPT_Value_Tempd	-671088.64° - 670433.28°	[Tx] Setpoint Offset	Float Offset Value
128	2 Bytes	O	CR-T-	DPT_Value_Temp	-273.00° - 670433.28°	[Tx] Setpoint Status	Current Setpoint
129	2 Bytes	O	CR-T-	DPT_Value_Temp	-273.00° - 670433.28°	[Tx] Basic Setpoint Status	Current Basic Setpoint
130	2 Bytes	O	CR-T-	DPT_Value_Tempd	-671088.64° - 670433.28°	[Tx] Setpoint Offset Status	Current Setpoint Offset
131	1 Bit	I	C-W--	DPT_Reset	0/1	[Tx] Setpoint Reset	Reset Setpoint to Default
	1 Bit	I	C-W--	DPT_Reset	0/1	[Tx] Offset Reset	Reset Offset
132	1 Bit	I	C-W--	DPT_Heat_Cool	0/1	[Tx] Mode	0 = Cool; 1 = Heat
133	1 Bit	O	CR-T-	DPT_Heat_Cool	0/1	[Tx] Mode Status	0 = Cool; 1 = Heat
134	1 Bit	I	C-W--	DPT_Switch	0/1	[Tx] On/Off	0 = Off; 1 = On
135	1 Bit	O	CR-T-	DPT_Switch	0/1	[Tx] On/Off Status	0 = Off; 1 = On
136	1 Bit	I/O	CRW--	DPT_Switch	0/1	[Tx] Main System (Cool)	0 = System 1; 1 = System 2
137	1 Bit	I/O	CRW--	DPT_Switch	0/1	[Tx] Main System (Heat)	0 = System 1; 1 = System 2
138	1 Bit	I	C-W--	DPT_Enable	0/1	[Tx] Enable/Disable Secondary System (Cool)	0 = Disable; 1 = Enable
139	1 Bit	I	C-W--	DPT_Enable	0/1	[Tx] Enable/Disable Secondary System (Heat)	0 = Disable; 1 = Enable
140, 146	1 Byte	O	CR-T-	DPT_Scaling	0% - 100%	[Tx] [Sx] Control Variable (Cool)	PI Control (Continuous)
141, 147	1 Byte	O	CR-T-	DPT_Scaling	0% - 100%	[Tx] [Sx] Control Variable (Heat)	PI Control (Continuous)
	1 Byte	O	CR-T-	DPT_Scaling	0% - 100%	[Tx] [Sx] Control Variable	PI Control (Continuous)
142, 148	1 Bit	O	CR-T-	DPT_Switch	0/1	[Tx] [Sx] Control Variable (Cool)	2-Point Control
	1 Bit	O	CR-T-	DPT_Switch	0/1	[Tx] [Sx] Control Variable (Cool)	PI Control (PWM)
143, 149	1 Bit	O	CR-T-	DPT_Switch	0/1	[Tx] [Sx] Control Variable (Heat)	2-Point Control
	1 Bit	O	CR-T-	DPT_Switch	0/1	[Tx] [Sx] Control Variable (Heat)	PI Control (PWM)
	1 Bit	O	CR-T-	DPT_Switch	0/1	[Tx] [Sx] Control Variable	2-Point Control
	1 Bit	O	CR-T-	DPT_Switch	0/1	[Tx] [Sx] Control Variable	PI Control (PWM)
144, 150	1 Bit	O	CR-T-	DPT_Switch	0/1	[Tx] [Sx] PI State (Cool)	0 = PI Signal 0%; 1 = PI Signal Greater than 0%
145, 151	1 Bit	O	CR-T-	DPT_Switch	0/1	[Tx] [Sx] PI State (Heat)	0 = PI Signal 0%; 1 = PI Signal Greater than 0%
	1 Bit	O	CR-T-	DPT_Switch	0/1	[Tx] [Sx] PI State	0 = PI Signal 0%; 1 = PI Signal Greater than 0%
152, 156	2 Bytes	O	CR-T-	DPT_Value_Temp	-273.00° - 670433.28°	[Ix] Current Temperature	Temperature Sensor Value
153, 157	1 Bit	O	CR-T-	DPT_Alarm	0/1	[Ix] Overcooling	0 = No Alarm; 1 = Alarm
154, 158	1 Bit	O	CR-T-	DPT_Alarm	0/1	[Ix] Overheating	0 = No Alarm; 1 = Alarm

155, 159	1 Bit	O	CR-T-	DPT_Alarm	0/1	[Ix] Probe Error	0 = No Alarm; 1 = Alarm
160	2 Bytes	O	CR-T-	DPT_Value_Temp	-273.00° - 670433.28°	[Internal Probe] Current Temperature	Temperature Sensor Value
161	1 Bit	O	CR-T-	DPT_Alarm	0/1	[Internal Probe] Overcooling	0 = No Alarm; 1 = Alarm
162	1 Bit	O	CR-T-	DPT_Alarm	0/1	[Internal Probe] Overheating	0 = No Alarm; 1 = Alarm
163	1 Byte	I	C-W--	DPT_SceneNumber	0 - 63	[Motion Detector] Scene Input	Scene Value
164	1 Byte		C--T-	DPT_SceneControl	0-63; 128-191	[Motion Detector] Scene Output	Scene Value
165, 194	1 Byte	O	CR-T-	DPT_Scaling	0% - 100%	[Ix] Luminosity	0-100%
166, 195	1 Bit	O	CR-T-	DPT_Alarm	0/1	[Ix] Open Circuit Error	0 = No Error; 1 = Open Circuit Error
167, 196	1 Bit	O	CR-T-	DPT_Alarm	0/1	[Ix] Short Circuit Error	0 = No Error; 1 = Short Circuit Error
168, 197	1 Byte	O	CR-T-	DPT_Scaling	0% - 100%	[Ix] Presence State (Scaling)	0-100%
169, 198	1 Byte	O	CR-T-	DPT_HVACMode	1=Comfort 2=Standby 3=Economy 4=Building Protection	[Ix] Presence State (HVAC)	Auto, Comfort, Standby, Economy, Building Protection
170, 199	1 Bit	O	CR-T-	DPT_Switch	0/1	[Ix] Presence State (Binary)	Binary Value
	1 Bit	O	CR-T-	DPT_Start	0/1	[Ix] Presence: Slave Output	1 = Motion Detected
171, 200	1 Bit	I	C-W--	DPT_Window_Door	0/1	[Ix] Presence Trigger	Binary Value to Trigger the Presence Detection
172, 201	1 Bit	I	C-W--	DPT_Start	0/1	[Ix] Presence: Slave Input	0 = Nothing; 1 = Detection from slave device
173, 202	2 Bytes	I	C-W--	DPT_TimePeriodSec	0 - 65535	[Ix] Presence: Waiting Time	0-65535 s.
174, 203	2 Bytes	I	C-W--	DPT_TimePeriodSec	0 - 65535	[Ix] Presence: Listening Time	1-65535 s.
175, 204	1 Bit	I	C-W--	DPT_Enable	0/1	[Ix] Presence: Enable	According to parameters
176, 205	1 Bit	I	C-W--	DPT_DayNight	0/1	[Ix] Presence: Day/Night	According to parameters
177, 206	1 Bit	O	CR-T-	DPT_Occupancy	0/1	[Ix] Presence: Occupancy State	0 = Not Occupied; 1 = Occupied
178, 207	1 Bit	I	C-W--	DPT_Start	0/1	[Ix] External Motion Detection	0 = Nothing; 1 = Motion detected by an external sensor
179, 184, 189, 208, 213, 218	1 Byte	O	CR-T-	DPT_Scaling	0% - 100%	[Ix] [Cx] Detection State (Scaling)	0-100%
180, 185, 190, 209, 214, 219	1 Byte	O	CR-T-	DPT_HVACMode	1=Comfort 2=Standby 3=Economy 4=Building Protection	[Ix] [Cx] Detection State (HVAC)	Auto, Comfort, Standby, Economy, Building Protection
181, 186, 191, 210, 215, 220	1 Bit	O	CR-T-	DPT_Switch	0/1	[Ix] [Cx] Detection State (Binary)	Binary Value
182, 187, 192, 211, 216, 221	1 Bit	I	C-W--	DPT_Enable	0/1	[Ix] [Cx] Enable Channel	According to parameters
183, 188, 193, 212, 217, 222	1 Bit	I	C-W--	DPT_Switch	0/1	[Ix] [Cx] Force State	0 = No Detection; 1 = Detection
223, 229	1 Bit	I	C-W--	DPT_Enable	0/1	[Ix] Input Lock	0 = Unlock; 1 = Lock
224, 230	1 Bit		C--T-	DPT_Switch	0/1	[Ix] [Short Press] 0	Sending of 0
	1 Bit		C--T-	DPT_Switch	0/1	[Ix] [Short Press] 1	Sending of 1

1 Bit	I	C - WT -	DPT_Switch	0/1	[Ix] [Short Press] 0/1 Switching	Switching 0/1
1 Bit		C - - T -	DPT_UpDown	0/1	[Ix] [Short Press] Move Up Shutter	Sending of 0 (Up)
1 Bit		C - - T -	DPT_UpDown	0/1	[Ix] [Short Press] Move Down Shutter	Sending of 1 (Down)
1 Bit		C - - T -	DPT_UpDown	0/1	[Ix] [Short Press] Move Up/Down Shutter	Switching 0/1 (Up/Down)
1 Bit		C - - T -	DPT_Step	0/1	[Ix] [Short Press] Stop/Step Up Shutter	Sending of 0 (Stop/Step Up)
1 Bit		C - - T -	DPT_Step	0/1	[Ix] [Short Press] Stop/Step Down Shutter	Sending of 1 (Stop/Step Down)
1 Bit		C - - T -	DPT_Step	0/1	[Ix] [Short Press] Stop/Step Shutter (Switched)	Switching of 0/1 (Stop/Step Up/Down)
4 Bit		C - - T -	DPT_Control_Dimming	0x0 (Stop) 0x1 (Dec. by 100%) ... 0x7 (Dec. by 1%) 0x8 (Stop) 0xD (Inc. by 100%) ... 0xF (Inc. by 1%)	[Ix] [Short Press] Brighter	Increase Brightness
4 Bit		C - - T -	DPT_Control_Dimming	0x0 (Stop) 0x1 (Dec. by 100%) ... 0x7 (Dec. by 1%) 0x8 (Stop) 0xD (Inc. by 100%) ... 0xF (Inc. by 1%)	[Ix] [Short Press] Darker	Decrease Brightness
4 Bit		C - - T -	DPT_Control_Dimming	0x0 (Stop) 0x1 (Dec. by 100%) ... 0x7 (Dec. by 1%) 0x8 (Stop) 0xD (Inc. by 100%) ... 0xF (Inc. by 1%)	[Ix] [Short Press] Brighter/Darker	Switch Bright/Dark
1 Bit		C - - T -	DPT_Switch	0/1	[Ix] [Short Press] Light On	Sending of 1 (On)
1 Bit		C - - T -	DPT_Switch	0/1	[Ix] [Short Press] Light Off	Sending of 0 (Off)
1 Bit	I	C - WT -	DPT_Switch	0/1	[Ix] [Short Press] Light On/Off	Switching 0/1
1 Byte		C - - T -	DPT_SceneControl	0-63; 128-191	[Ix] [Short Press] Run Scene	Sending of 0 - 63
1 Byte		C - - T -	DPT_SceneControl	0-63; 128-191	[Ix] [Short Press] Save Scene	Sending of 128 - 191
1 Bit	I/O	CRWT -	DPT_Switch	0/1	[Ix] [Switch/Sensor] Edge	Sending of 0 or 1
1 Byte		C - - T -	DPT_Value_1_Ucount	0 - 255	[Ix] [Short Press] Constant Value (Integer)	0 - 255
1 Byte		C - - T -	DPT_Scaling	0% - 100%	[Ix] [Short Press] Constant Value (Percentage)	0% - 100%

	2 Bytes		C--T-	DPT_Value_2_Ucount	0 - 65535	[Ix] [Short Press] Constant Value (Integer)	0 - 65535
	2 Bytes		C--T-	9.xxx	-671088.64 - 670433.28	[Ix] [Short Press] Constant Value (Float)	Float Value
225, 231	1 Byte	I	C-W--	DPT_Scaling	0% - 100%	[Ix] [Short Press] Shutter Status (Input)	0% = Top; 100% = Bottom
	1 Byte	I	C-W--	DPT_Scaling	0% - 100%	[Ix] [Short Press] Dimming Status (Input)	0% - 100%
226, 232	1 Bit		C--T-	DPT_Switch	0/1	[Ix] [Long Press] 0	Sending of 0
	1 Bit		C--T-	DPT_Switch	0/1	[Ix] [Long Press] 1	Sending of 1
	1 Bit	I	C-WT-	DPT_Switch	0/1	[Ix] [Long Press] 0/1 Switching	Switching 0/1
	1 Bit		C--T-	DPT_UpDown	0/1	[Ix] [Long Press] Move Up Shutter	Sending of 0 (Up)
	1 Bit		C--T-	DPT_UpDown	0/1	[Ix] [Long Press] Move Down Shutter	Sending of 1 (Down)
	1 Bit		C--T-	DPT_UpDown	0/1	[Ix] [Long Press] Move Up/Down Shutter	Switching 0/1 (Up/Down)
	1 Bit		C--T-	DPT_Step	0/1	[Ix] [Long Press] Stop/Step Up Shutter	Sending of 0 (Stop/Step Up)
	1 Bit		C--T-	DPT_Step	0/1	[Ix] [Long Press] Stop/Step Down Shutter	Sending of 1 (Stop/Step Down)
	1 Bit		C--T-	DPT_Step	0/1	[Ix] [Long Press] Stop/Step Shutter (Switched)	Switching of 0/1 (Stop/Step Up/Down)
	4 Bit		C--T-	DPT_Control_Dimming	0x0 (Stop) 0x1 (Dec. by 100%) ... 0x7 (Dec. by 1%) 0x8 (Stop) 0xD (Inc. by 100%) ... 0xF (Inc. by 1%)	[Ix] [Long Press] Brighter	Long Pr. -> Brighter; Release -> Stop
	4 Bit		C--T-	DPT_Control_Dimming	0x0 (Stop) 0x1 (Dec. by 100%) ... 0x7 (Dec. by 1%) 0x8 (Stop) 0xD (Inc. by 100%) ... 0xF (Inc. by 1%)	[Ix] [Long Press] Darker	Long Pr. -> Darker; Release -> Stop
	4 Bit		C--T-	DPT_Control_Dimming	0x0 (Stop) 0x1 (Dec. by 100%) ... 0x7 (Dec. by 1%) 0x8 (Stop) 0xD (Inc. by 100%) ... 0xF (Inc. by 1%)	[Ix] [Long Press] Brighter/Darker	Long Pr. -> Brighter/Darker; Release -> Stop
	1 Bit		C--T-	DPT_Switch	0/1	[Ix] [Long Press] Light On	Sending of 1 (On)

	1 Bit		C--T-	DPT_Switch	0/1	[Ix] [Long Press] Light Off	Sending of 0 (Off)
	1 Bit	I	C-WT-	DPT_Switch	0/1	[Ix] [Long Press] Light On/Off	Switching 0/1
	1 Byte		C--T-	DPT_SceneControl	0-63; 128-191	[Ix] [Long Press] Run Scene	Sending of 0 - 63
	1 Byte		C--T-	DPT_SceneControl	0-63; 128-191	[Ix] [Long Press] Save Scene	Sending of 128 - 191
	1 Bit	O	CR-T-	DPT_Alarm	0/1	[Ix] [Switch/Sensor] Alarm: Breakdown or Sabotage	1 = Alarm; 0 = No Alarm
	2 Bytes		C--T-	9.xxx	-671088.64 - 670433.28	[Ix] [Long Press] Constant Value (Float)	Float Value
	2 Bytes		C--T-	DPT_Value_2_Ucount	0 - 65535	[Ix] [Long Press] Constant Value (Integer)	0 - 65535
	1 Byte		C--T-	DPT_Scaling	0% - 100%	[Ix] [Long Press] Constant Value (Percentage)	0% - 100%
	1 Byte		C--T-	DPT_Value_1_Ucount	0 - 255	[Ix] [Long Press] Constant Value (Integer)	0 - 255
227, 233	1 Bit		C--T-	DPT_Trigger	0/1	[Ix] [Long Press/Release] Stop Shutter	Release -> Stop Shutter
228, 234	1 Byte	I	C-W--	DPT_Scaling	0% - 100%	[Ix] [Long Press] Dimming Status (Input)	0% - 100%
	1 Byte	I	C-W--	DPT_Scaling	0% - 100%	[Ix] [Long Press] Shutter Status (Input)	0% = Top; 100% = Bottom

Join and send us your inquiries
about Zennio devices:

<https://support.zennio.com>

Zennio Avance y Tecnología S.L.
C/ Río Jarama, 132. Nave P-8.11
45007 Toledo (Spain).

Tel. +34 925 232 002.

www.zennio.com
info@zennio.com



RoHS