

Technical Manual

MDT Switch Actuator



Series AKI:

AKI-0416.03
AKI-0816.03
AKI-1216.03

Series AKS:

AKS-0416.03
AKS-0816.03
AKS-1216.03
AKS-1616.03
AKS-2016.03

Series AKK:

AKK-01UP.03
AKK-02UP.03
AKK-0216.03
AKK-0816.03
AKK-1616.03

1 Content

1 Content.....	2
2 Overview.....	4
2.1 Overview devices.....	4
2.1.1 Industrial design AKI.....	4
2.1.2 Compact bistable design AKS	4
2.1.3 Compact design AKK, monostable/bistable	4
2.2 Exemplary circuit diagrams	5
2.2.1 AKI.....	5
2.2.2 AKS.....	6
2.2.3 AKK	6
2.3 Structure & Handling.....	7
2.4 Functions	8
2.4.1 Overview functions.....	8
2.5. Settings at the ETS-Software	9
2.6. Starting up	9
3 Communication objects.....	10
3.1 Summary and Usage.....	10
3.2 Default settings of the communication objects	15
4 Reference ETS-Parameter	16
4.1 General Settings	16
4.2 Channel selection	17
4.3 Identical parameter	18
4.3.1 Relay operating mode	18
4.3.2 Central function.....	19
4.3.3 Behavior at locking/unlocking.....	19
4.3.4 Behavior at bus power down/bus power up.....	20
4.3.5 On/Off delay	21
4.3.6 State functions.....	22
4.3.7 Priority/Forced control.....	23
4.3.8 Logic functions.....	24
4.3.9 Scenes.....	26
4.3.10 Threshold switch	29
4.3.11 Operating hours counter	30
4.3.12 Diagram switching output	32

4.4 Staircase light	33
4.4.1 Relay operating mode	33
4.4.2 Central function.....	34
4.4.3 Behavior at locking/unlocking	34
4.4.4 Behavior at bus power down/bus power up.....	35
4.4.5 State functions.....	36
4.4.6 Priority/Forced control	38
4.4.7 Scenes.....	39
4.4.8 Staircase with variable time	42
4.4.9 Prewarning function	42
4.4.10 Manual switch off.....	44
4.4.11 Extend time of staircase light	44
4.4.12 Additional switching object	45
4.5 Switch pulse.....	46
4.5.1 Relay operating mode	46
4.5.2 Pulse function.....	47
4.5.3 Locking function	48
5 Index.....	49
5.1 Register of illustrations.....	49
5.2 List of tables.....	50
6 Attachment.....	51
6.1 Statutory requirements.....	51
6.2 Routine disposal	51
6.3 Assemblage.....	51
6.4 History	52
6.5 Datasheet	53

2 Overview

2.1 Overview devices

The manual refers to the following devices (Order Code respectively printed in bold type). For the actuators with integrated current measurement, a separate manual exists.

2.1.1 Industrial design AKI

- **AKI-0416.03** Switch actuator 4-fold, 4TE, 230V AC, 16 A, C-Load 200 μ F, industrial design
- **AKI-0816.03** Switch actuator 8-fold, 8TE, 230V AC, 16 A, C-Load 200 μ F, industrial design
- **AKI-1216.03** Switch actuator 12-fold, 12TE, 230V AC, 16 A, C-Load 200 μ F, industrial design

2.1.2 Compact bistable design AKS

- **AKS-0416.32** Switch actuator 4-fold, 4TE, 230V AC 16A, C-Load 140 μ F, new series
- **AKS-0816.03** Switch actuator 8-fold, 6TE, 230V AC 16A, C-Load 140 μ F, new series
- **AKS-1216.03** Switch actuator 12-fold, 8TE, 230V AC 16A, C-Load 140 μ F, new series
- **AKS-2016.03** Switch actuator 20-fold, 12TE, 230V AC 16A, C-Load 140 μ F, new series

2.1.3 Compact design AKK, monostable/bistable

- **AKK-01UP.03** Switch actuator 1-fold, UP 16A, 230V AC, C-Last 70 μ F, bistable relays
- **AKK-02UP.03** Switch actuator 2-fold, UP 10A, 230V AC, C-Last 14 μ F, monostable relays
- **AKK-0216.03** Switch actuator 2-fold, 2 TE, 16A, 230V AC, C-Last 70 μ F, bistable relays
- **AKK-0416.03** Switch actuator 4-fold, 2TE, 230V AC 16A, C-Last 70 μ F, bistable relays
- **AKK-0816.03** Switch actuator 12-fold, 4TE, 230V AC 16A, C-Last 70 μ F, bistable relays
- **AKK-1616.03** Switch actuator 16-fold, 8TE, 230V AC 16A, C-Last 70 μ F, bistable relays

2.2 Exemplary circuit diagrams

2.2.1 AKI

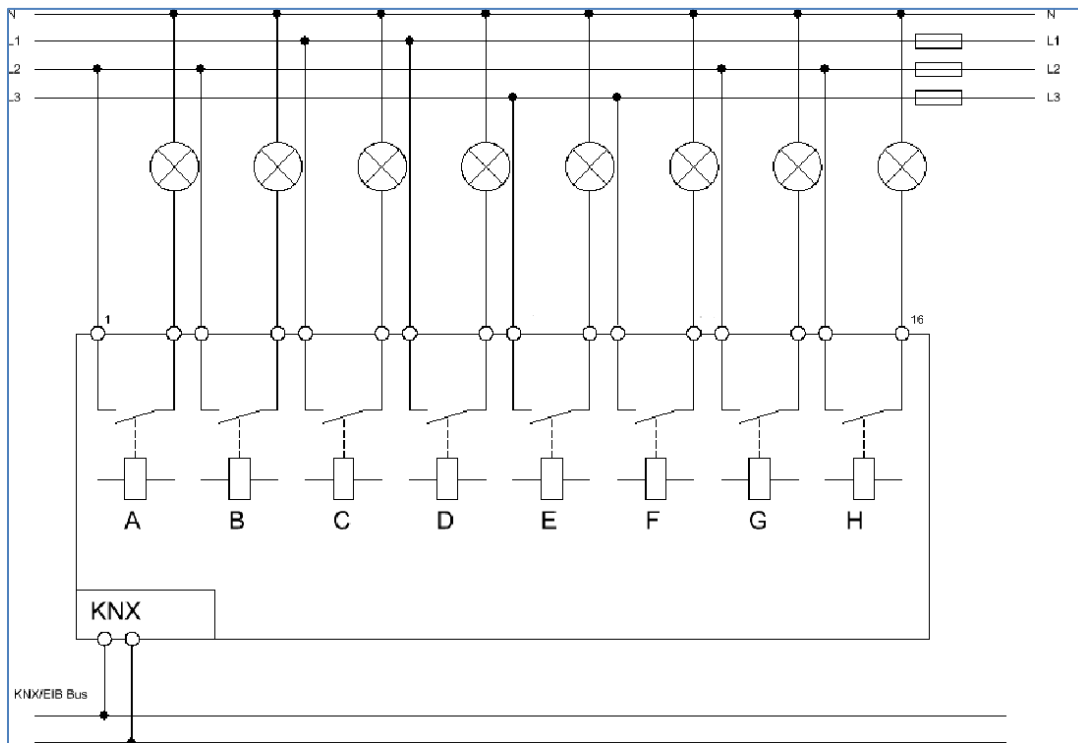

Figure 1: Exemplary circuit diagram AKI-0816.03

2.2.2 AKS

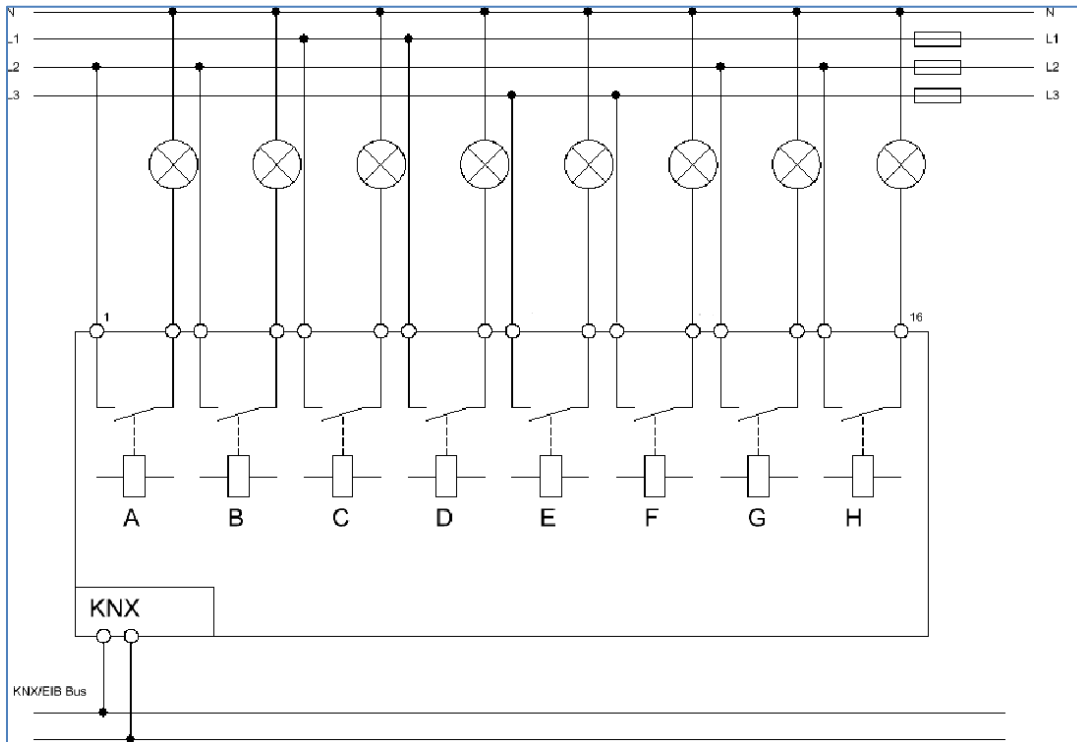

Figure 2: Exemplary circuit diagram AKS-0816.03

2.2.3 AKK

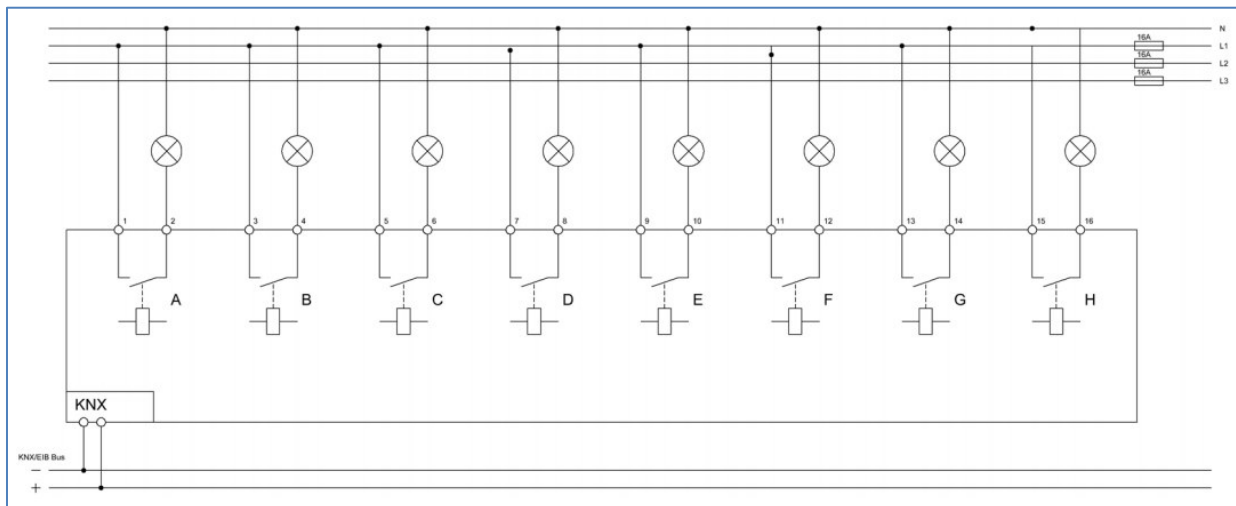

Figure 3: Exemplary circuit diagram AKK-0816.03

2.3 Structure & Handling

The following figure shows the structure of the switch actuators:



Figure 4: Structure & Handling – here AKI-0816.03

Every channel has a green state LED, which lights green when the channel is switched on. According to the parametrization, every channel can be switched via the blue button (here A-H) at the device. For programming the physical address, the programming button must be pressed for at least 1 sec. An active programming mode is shown by the red LED above the programming button.

2.4 Functions

Each channel of the switching actuators of the 03 series (e.g. AKS-2016.03) can be parameterized as switching output, staircase function or for generating switch impulses. Furthermore the channels from B can be adjusted, with only one “Click”, with the same setting as channel A. Also a synchronous switching function is available. So the channels from B can be switched synchronous with channel A.

The functionality of a switching output, the staircase function and the switch impulse can be seen at the following chapter.

2.4.1 Overview functions

Setting channel	Functions
Switching	<ul style="list-style-type: none"> • Operating mode normally closed/normally opened • On/Off Delay • Central Function • State and invert able state with different sending conditions • Blocking function • Priority and 2 Bit forced operation • Behavior at bus power failure and bus power reset adjustable • Logical functions (Or, And, Xor, Gate-function) with up to 2 additional logic objects • up to 8 scenes per channel • Threshold function for 1 Byte or 2 Byte • Operation hour counter and reverse counter to service
Staircase light	<ul style="list-style-type: none"> • Operating mode normally closed/normally opened • Central Function • State and invert able state with different sending conditions • Staircase light with pre-warning and warning time adjustable • Manual switch off • additional switching object (for continuous on) available • variable Staircase time via 1 Byte input • Blocking function • Priority and 2 Bit forced function • Behavior at bus power failure and bus power reset adjustable • up to 8 scenes per channel

switch pulse	<ul style="list-style-type: none"> • Operating mode normally closed/normally opened • adjustable pulse time • pulse can be repeated with adjustable time in between • Blocking function
use settings of channel A	Channel takes the same settings as channel A
switch synchronous with channel A	Channel switches synchronous with channel A

Table 1: Overview functions

2.5. Settings at the ETS-Software

Selection at the product database:

Manufacturer: MDT Technologies

Product family: Actuator

Product type: Switch Actuators

Medium Type: Twisted Pair (TP)

Product name: addicted to the used type, e.g.: AKI-1216.01 switch actuator 12-fold, 8TE, 16A

Order number: addicted to the used type, e.g.: AKI-1216.01

2.6. Starting up

After wiring, the allocation of the physical address and the parameterization of every channel follow:

- (1) Connect the interface with the bus, e.g. MDT USB interface
- (2) Switching the power supply
- (3) Set bus power up
- (4) Press the programming button at the device (red programming LED lights)
- (5) Loading of the physical address out of the ETS-Software by using the interface (red LED goes out, as well this process was completed successful)
- (6) Loading of the application, with requested parameterization
- (7) If the device is enabled you can test the requested functions (also possible by using the ETS-Software)

3 Communication objects

3.1 Summary and Usage

No.	Name	Object function	Data Point	Direction	Info	Usage	Note
global objects:							
depending on the number of channels	Central function	Switch On/Off	DPT 1.001	receive	Actuator responds to input telegram	Control buttons, Visu ... for manual operation	Object is always shown enables control of basic functions Switch on / off for all channels with activated central function
depending on the number of channels	Central function	Lock hand control	DPT 1.003	receive	Actuator responds to input telegram	Control buttons, Visu ... for manual operation	Object can be activated via Parameter settings and allows locking the manual control.
depending on the number of channels	Central function	Operation	DPT 1.011	receive	Actuator sends state	Failure detection, diagnostic, Visu	Object can be activated via Parameter settings and allows sending of a cyclic device state.

Technical Manual Switch Actuators AKI/AKS/AKK

Objects per channel:							
0	Channel A	Switch On/Off	DPT 1.001	receive	Actuator responds to input telegram	Control buttons, Visu ... for manual operation	Basic function of the switching function, Communication object allows switching the output on/off.
1	Channel A	Staircase light	DPT 1.001	receive	Actuator responds to input telegram	Control buttons, Visu ... for manual operation	Basic function of the staircase function, Communication object allows switching the output for the adjusted staircase time.
1	Channel A	Service required	DPT 1.005	send	Actuator sends state	Display, Visu, status function	Additional function of the function switching, Object reports expiration of the service interval not available at AKK series
1	Channel A	Switch pulse	DPT 1.001	receive	Actuator responds to input telegram	Control buttons, Visu ... for manual operation	Basic function of the function switch pulse, Communication object allows the pulsed switching of the output.
2	Channel A	Lock	DPT 1.003	receive	Actuator responds to input telegram	Control buttons, Visu ... for manual operation	Additional function for all functions, Object allows locking the channel.

Technical Manual Switch Actuators AKI/AKS/AKK

2	Channel A	Time to next service	DPT 7.007/ DPT 13.100	send	Actuator sends state	Visu, Diagnose	Additional function of the function switching, Object sends state of the service not available at AKK series
2	Channel A	Response operating hours	DPT 7.007/ DPT 13.100	send	Actuator sends state	Visu, Diagnose	Additional function of the function switching, Object sends state of the operating hours not available at AKK series
2	Channel A	Staircase light with time	DPT 5.005	receive	Actuator responds to input telegram	Control buttons, Visu ... for manual operation	Basic function of the staircase function, Communication object allows starting the staircase light with any time.
3	Channel A	Prewarning	DPT 1.001	send	Actuator sends state	Display, Visu, status function	Additional function of the function switching, Object warns of the expiration of the staircase time.
3	Channel A	Reset operating hours	DPT 1.001	receive	Actuator responds to input telegram	Control buttons, Visu ... for manual operation	Additional function of the function switching, Object resets the operating hours not available at AKK series
3	Channel A	Reset service	DPT 1.001	receive	Actuator responds to input telegram	Control buttons, Visu ... for manual operation	Additional function of the function switching, Object resets the service not available at AKK series

Technical Manual Switch Actuators AKI/AKS/AKK

5	Channel A	Forced control	DPT 2.001	receive	Actuator responds to input telegram	Control buttons, Visu ... for manual operation	Additional function of the function switching and staircase, Object sets the forced control.
5	Channel A	Priority	DPT 1.001	receive	Actuator responds to input telegram	Control buttons, Visu ... for manual operation	Additional function of the function switching and staircase, Object switches the priority.
6	Channel A	Scene	DPT 17.001	receive	Actuator responds to input telegram	Control buttons, Visu ... for manual operation	Additional function of the function switching and staircase, Object calls scenes.
7	Channel A	State	DPT 1.011	send	Actuator sends state	Display, Visu, status function	Additional function of the function switching and staircase, Object sends the state of the channel.
8	Channel A	inverted state	DPT 1.011	send	Actuator sends state	Display, Visu, status function	Additional function of the function switching and staircase, Object sends the inverted state of the channel.
11	Channel A	Threshold switch	DPT 7.001/ DPT 9.001/ DPT 5.001/ DPT 9.004	receive	Actuator responds to input telegram	Measurement of temperature, brightness, etc.	Additional function of the function switching, Object evaluates measuring values of brightness or temperature not available at AKK series

Technical Manual Switch Actuators AKI/AKS/AKK

Logical functions per Channel:							
9	Channel A	Logic 1	DPT 1.001	receive	Actuator responds to input telegram	Control buttons, Visu ... for manual operation	Additional function of the function switching, Object switches the logic function.
10	Channel A	Logic 2	DPT 1.001	receive	Actuator responds to input telegram	Control buttons, Visu ... for manual operation	Additional function of the function switching, Object switches the logic function.

Table 2: Communication Objects

3.2 Default settings of the communication objects

The following chart shows the default settings of the communication objects:

Default settings									
No.	Name	Object Function	Length	Priority	C	R	W	T	U
0	Channel A	Switch On/Off	1 Bit	Low	X		X		
1	Channel A	Staircase light	1 Bit	Low	X		X		
1	Channel A	Service required	1 Bit	Low	X		X		
1	Channel A	Switch pulse	1 Bit	Low	X		X		
2	Channel A	Lock	1 Bit	Low	X		X		
2	Channel A	Time to next service	2 Byte/ 4 Byte	Low	X	X		X	
2	Channel A	Response operating hours	2 Byte/ 4 Byte	Low	X	X		X	
2	Channel A	Staircase light with time	1 Byte	Low	X		X		
3	Channel A	Prewarning	1 Bit	Low	X	X		X	
3	Channel A	Reset operating hours	1 Bit	Low	X		X		
3	Channel A	Reset service	1 Bit	Low	X		X		
5	Channel A	Forced control	2 Bit	Low	X		X		
5	Channel A	Priority	1 Bit	Low	X		X		
6	Channel A	Scene	1 Byte	Low	X		X		
7	Channel A	State	1 Bit	Low	X	X		X	
8	Channel A	inverted state	1 Bit	Low	X	X		X	
9	Channel A	Logic 1	1 Bit	Low	X		X		
10	Channel A	Logic 2	1 Bit	Low	X		X		
11	Channel A	Threshold switch	1 Byte/ 2 Byte	Low	X		X		
+12	Next Channel								
	Central function	Switch On/Off	1 Bit	Low	X		X		
	Central function	Lock hand control	1 Bit	Low	X		X		
	Central function	Operation	1 Bit	Low	X	X		X	

Table 3: Communication objects – default settings

You can see the default values for the communication objects from the upper chart. According to requirements the priority of the particular communication objects as well as the flags can be adjusted by the user. The flags allocates the function of the objects in the programming thereby stands C for communication, R for Read, W for write, T for transmit and U for update.

4 Reference ETS-Parameter

4.1 General Settings

The following figure shows the menu general settings:

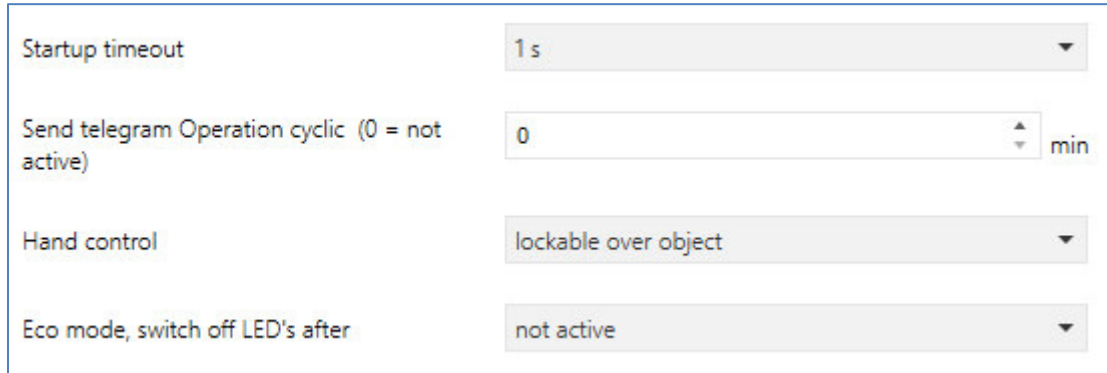

Figure 5: General settings

The following table shows the general settings:

ETS-Text	Dynamic Range [Default value]	Comment
Startup timeout	1..60s [1]	Time which elapses between a restart of the device and the functional start
Send „Operation-telegram“ cyclic	0-30000min [0]	Activates a cyclic „Operating-Telegram“
Manual Control	<ul style="list-style-type: none"> ▪ active ▪ locked ▪ lockable via object 	Adjustment of the manual control
Eco mode, switch LEDs off after	<ul style="list-style-type: none"> ▪ not active ▪ 30s-1h <p style="text-align: center;">[not active]</p>	Adjustment of the LED behavior

Table 4: General settings

4.2 Channel selection

The following figure shows the menu for selecting the channels:

Channel A	staircase light ▼
Channel B	switch synchronous with Channel A ▼
Channel C	switch impulse ▼
Channel D	switching ▼
Channel E	use settings of Channel A ▼
Channel F	switching ▼

Figure 6: Channel selection

The chart shows the setting options for every channel:

ETS-text	Dynamic range [default value]	comment
Channel A-[T]	<ul style="list-style-type: none"> ▪ not active ▪ Switching ▪ Staircase light ▪ use settings of Channel A ▪ switch synchronous with Channel A 	Operating mode of the channels

Table 5: Channel selection

According to the adjusted function, the parameter for each channel is shown.

The setting “use settings of Channel A” cause that the channel takes the same setting as Channel A. So there are no parameters shown for this channel and the same communication objects as in channel A are shown.

The setting “switch synchronous with Channel A” causes that the channel switches always to the same time as channel A. So, no further settings are shown for this channel.

4.3 Identical parameter

4.3.1 Relay operating mode

The following illustration shows the setting options for this parameter:

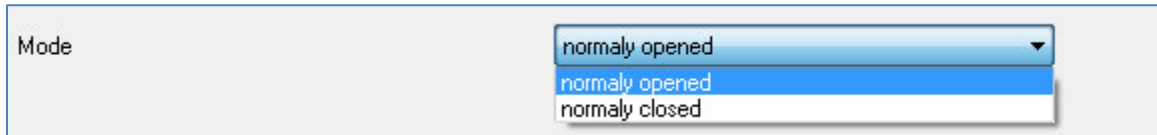

Figure 7: Operating mode

The following chart shows the dynamic range for this parameter:

ETS-text	Dynamic range [default value]	comment
Mode	<ul style="list-style-type: none"> ▪ normally opened ▪ normally closed 	Relay operating mode of the channel

Table 6: Operating mode

The following diagram shows the behavior of the relay operating mode normally closed and normally opened. The input for the channels is a KNX-telegram, which sends alternating 0-signals and 1-signals:

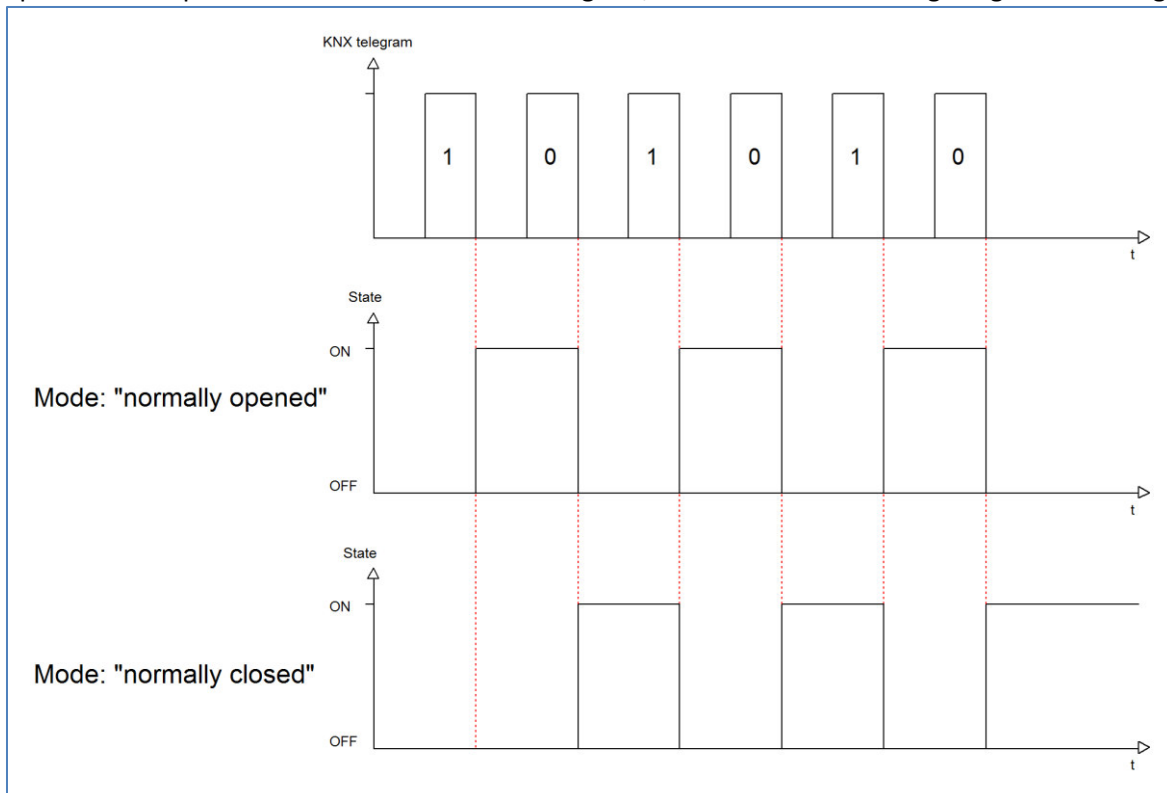

4.3.2 Central function

The following illustration shows the setting options at the ETS-Software:

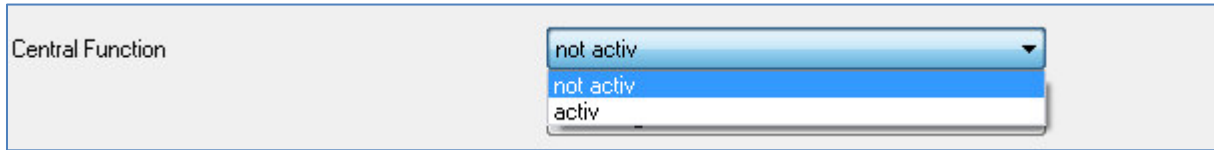

Figure 8: Central function

The following chart shows the dynamic range for this parameter:

ETS-text	Dynamic range [default value]	comment
Central function	<ul style="list-style-type: none"> ▪ not active ▪ active 	switches the central function on/off for this channel

Table 7: Central function

The central function can be switched on/off for every channel. For switching on this function, you have to choose the option “active”. By calling the central communication object, all channels with an activated central function are switched on with their current parameterization. So switch-on delays or staircase functions are still kept.

The central function can make programming much more easier and your project can become more clear.

The following chart shows the associated communication object:

Number	Name	Length	Usage
	Central function	1 Bit	central switching of the channels

Table 8: Communication object central function

4.3.3 Behavior at locking/unlocking

The following figure shows the available settings:

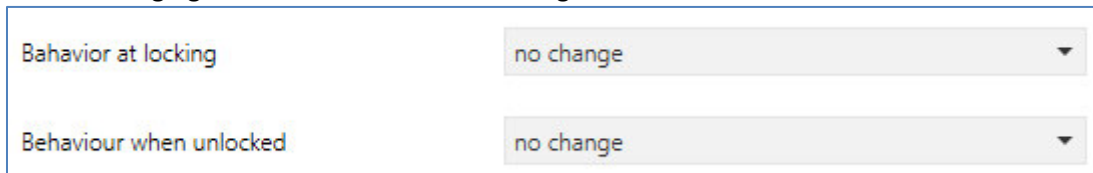

Figure 9: Behavior at locking/unlocking

The following table shows the available settings:

ETS-text	Dynamic range [default value]	comment
Behavior at locking	<ul style="list-style-type: none"> ▪ On ▪ Off ▪ no change 	Behavior at activating the locking function
Behavior at unlocking	<ul style="list-style-type: none"> ▪ On ▪ Off ▪ no change ▪ previous state, catch up on switching ▪ previous state 	Behavior at deactivating the locking function

Table 9: Behavior at locking/unlocking

A Channel is locked by sending a logical 1 to the locking object and further control is no longer available as long as the channel is locked. By sending a logical 0 the channel can be unlocked again. The following actions can be performed at locking/unlocking:

- **no change**
The channel stays in the current state.
- **On**
The channel is switched on.
- **Off**
The channel is switched off.
- **previous state, catch up on switching (only at unlocking)**
The channel restores the state before locking in compliance with the last switching command, which was sent during the channel was locked.
- **previous state (only at unlocking)**
The channel restores the state before locking.

The following table shows the communication object:

Number	Name	Length	Usage
4	Lock	1 Bit	Object for locking/unlocking

Table 10: Communication object for locking/unlocking

4.3.4 Behavior at bus power down/bus power up

The following figure shows the available settings:

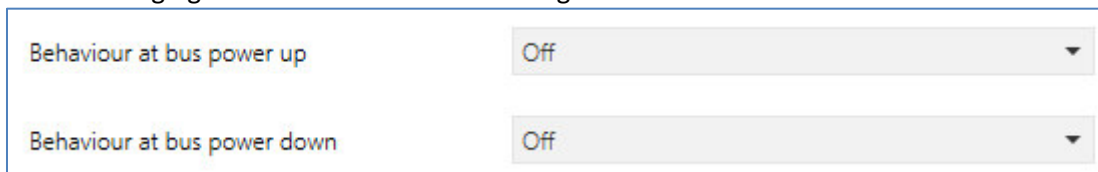

Figure 10: Behavior at bus power down/up

The following table shows the available settings for the behavior at bus power down/up:

ETS-text	Dynamic range [default value]	comment
Behavior at bus power up	<ul style="list-style-type: none"> ▪ Off ▪ On ▪ no change 	Behavior at bus power failures
Behavior at bus power down	<ul style="list-style-type: none"> ▪ Off ▪ On ▪ no change 	Behavior when bus power returns

Table 11: Behavior at bus power down/up

4.3.5 On/Off delay

The following illustration shows the setting options at the ETS-Software:

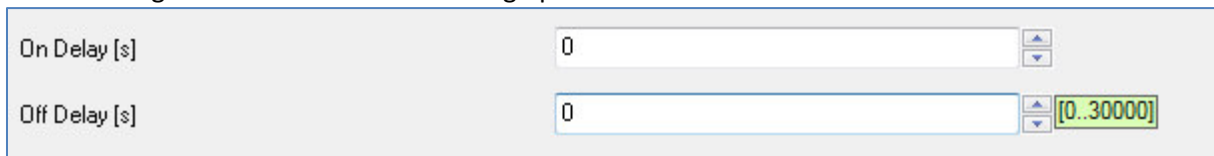

Figure 11: On/Off delay

The on-delay causes a delayed switch of the channel. At sending an on-signal to the channel, first the adjusted on delay time expires and afterwards the channel will be switched on.

The off delay works on the same principle. At sending an off-signal, first the adjusted off delay time expires and afterwards the channel will be switched off.

Both functions work as well alone as combined. By adjusting "0 seconds" for a delay the function is switched off.

The following diagram describes the combination of on and off delay:

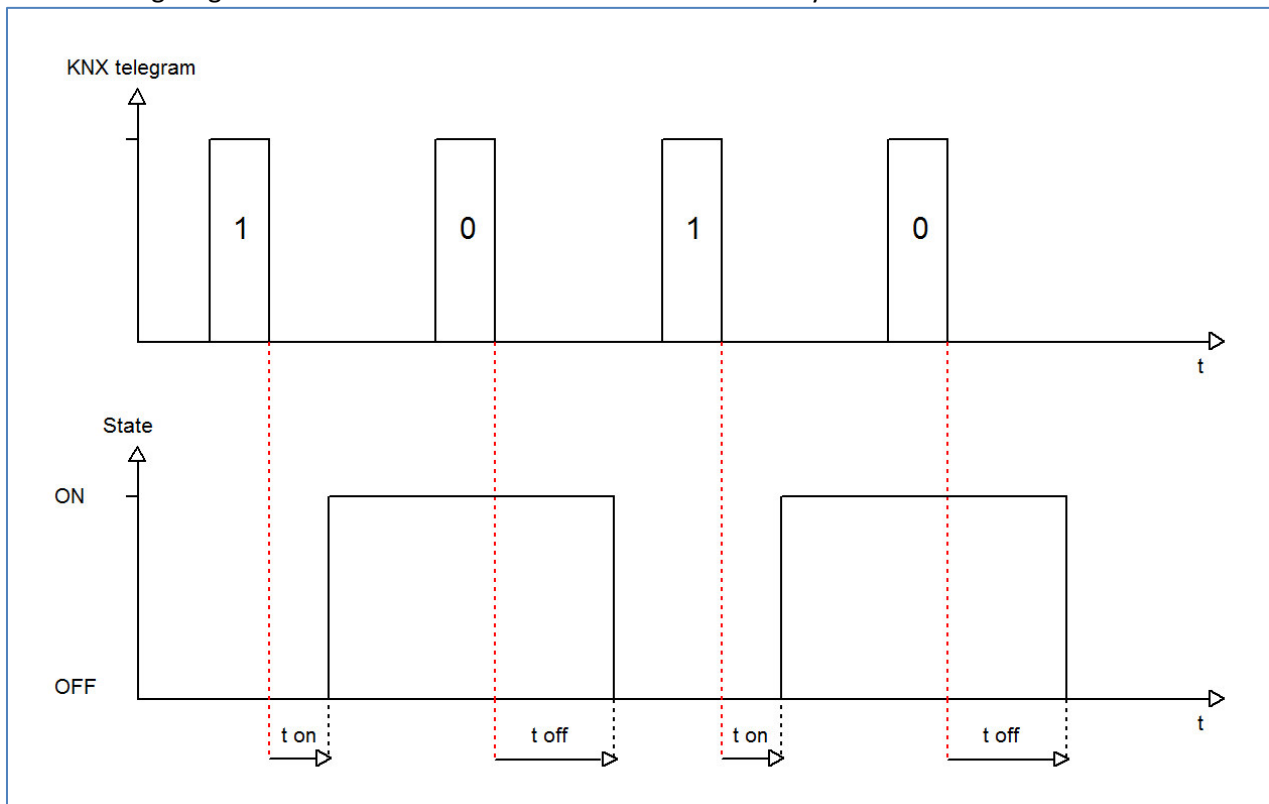

4.3.6 State functions

The following figure shows the available state functions:

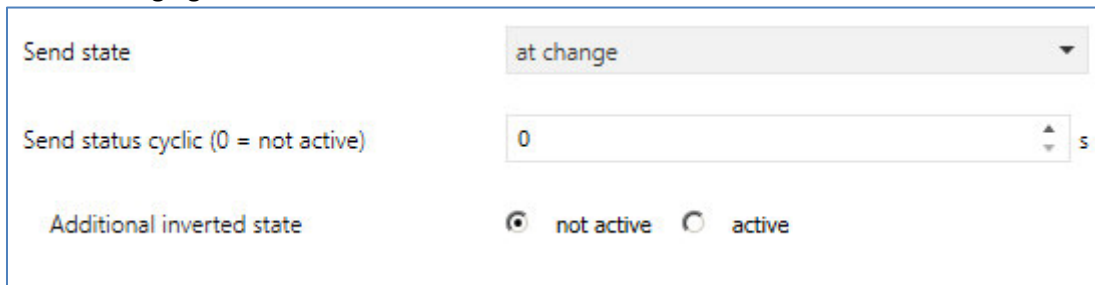

Figure 12: State functions

The following settings are available:

ETS-text	Dynamic range [default value]	comment
Send state	<ul style="list-style-type: none"> ▪ no send, passive state object ▪ at change ▪ at change and lock ▪ always at input of telegram 	Sending behavior of the state object
Send state cyclic (0 = not active)	0-30000s [0s]	Cyclic sending of the state
Additional inverted state	<ul style="list-style-type: none"> ▪ not active ▪ active 	Displaying an additional inverted state

Table 12: State functions

The following sending behavior for the state is available:

- **no send, passive state object**
The state object does not send its current state and can only be requested.
- **at change**
The state object sends its current state at every change of the output.
- **at change and lock**
The state object sends its current state at every change of the output – also during the locking process. By sending the status during the locking is ensured that a switch after locking sends the correct value.
- **always at input of telegram**
The state is sent at every input of a telegram – independent whether the output is changed or not.

The additional inverted state can be used for visualization, etc. and has always the opposite value of the “normal” state.

The following table shows the communication objects:

Number	Name	Length	Usage
7	State	1 Bit	Sends the state of the channel
8	inverted state	1 Bit	Sends the inverted state of the channel

Table 13: Communication objects state function

4.3.7 Priority/Forced control

The following figure shows the parameter priority/forced control:

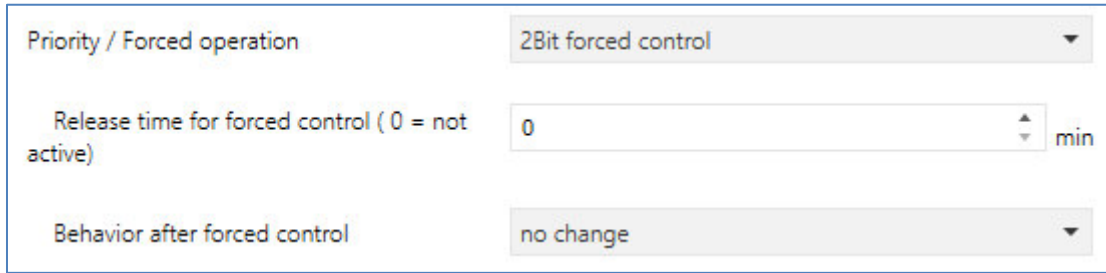

Figure 13: Priority/Forced control

The following settings are available:

ETS-text	Dynamic range [default value]	comment
Priority/Forced Control	<ul style="list-style-type: none"> ▪ not active ▪ 2 Bit forced control ▪ 1 Bit priority ON ▪ 1 Bit priority OFF 	Activation of the forced control/priority function
Release time for forced control (0 = not active)	0-600min [0 min]	Activation of a release time from the priority/forced control into the normal state.
Behavior after forced control/priority	<ul style="list-style-type: none"> ▪ On ▪ Off ▪ no change ▪ previous state, catch up on switching ▪ previous state 	Setting of the behavior after deactivating priority/forced control.

Table 14: Priority/Forced control

The priority/forced operation cause the priority switching of output. By using the release time, the priority/forced control can be deactivated automatically and the channel changes into the normal state.

The followings actions can be performed after deactivating the priority/forced control:

- **no change**
The channel stays in the current state.
- **On**
The channel is switched on.
- **Off**
The channel is switched off.
- **previous state, catch up on switching**
The channel restores the state before locking in compliance with the last switching command, which was sent during the channel was locked.
- **previous state**
The channel restores the state before locking.

The following table shows the communication object:

Number	Name	Length	Usage
5	Forced control/Priority	1 Bit	Activation/Deactivation of the forced control/priority

Table 15: Communication object priority/forced control

4.3.8 Logic functions

If the logical function is enabled, the following submenu for the logical function is shown:

Logic function	<input checked="" type="radio"/> with Switch object and one Logic object <input type="radio"/> with Switch object and two Logic objects
Logic operations	OR
Invert inputs	no invert
Invert output	<input checked="" type="radio"/> no invert <input type="radio"/> invert
Set objects to value after bus power up	<input checked="" type="radio"/> not active <input type="radio"/> active

Figure 14: Logic functions

The logic function can be activated with one or two additional logic objects. The logical function AND, OR, XOR and Gate-functions are available:

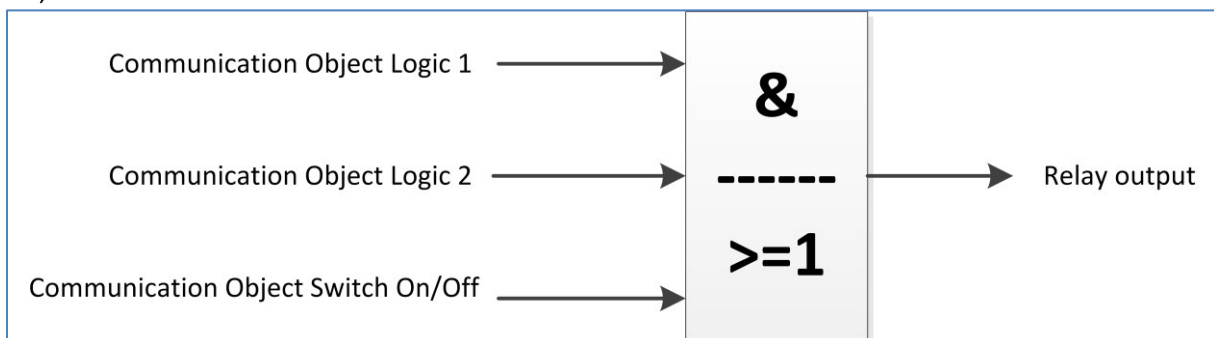

Figure 15: Logic function -> schematic diagram

The logical functions switch the output if the followings conditions are true:

- **AND**
All inputs are active (=1).
- **OR**
At least one input is active (=1).
- **XOR**
Only one input is active (=1).
- **Gate opened with logical functions = 0**
The output can be switched via the switching object if all logic objects have the value 0.
- **Gate opened with logical functions = 1**
The output can be switched via the switching object if all logic objects have the value 1.

Via the Parameter “Invert inputs/output”, the polarity of the input/output can be inverted.
 The parameter “Set object value after bus power up” defines if the logic is set to a fixed value after a bus power return.

The following table shows the available communication objects:

Number	Name	Length	Usage
9	Logic 1	1 Bit	Logic object 1, serves for the integration of a logic function
10	Logic 2	1 Bit	Logic object 2, serves for the integration of a logic function

Table 16: Communication objects logic

4.3.9 Scenes

When functions of different groups (e.g. light, heating and shutter) shall be changed simultaneously with only one keystroke, it is practical to use the scene function. By calling a scene, you can switch the lights to a specific value, drive the shutter to an absolute position, switch the heating to the day mode and switch the power supply of the sockets on. The telegrams of these functions can have as well different formats as different values with different meaning (e.g. "0" for switch the lights off and open the shutters). If there were no scene function, you would have to send a single telegram for every actuator to get the same function.

The scene function of the switch actuator enables you to connect the channels of the switch actuator to a scene control. For that, you have to assign the value to the appropriated space (scene A..H). It is possible to program up to 8 scenes per switching output. When you activate the scene function at the switching output, a new sub menu for the scenes appears at the left drop down menu. There are settings to activate single scenes, set values and scene numbers and switch the memory function on/off at this sub menu.

Scenes are activated by receiving their scene numbers at the communication object for the scenes. If the memory function of the scenes is activated, the current value of the channel will be saved at the called scene number.

The communication objects of the scenes have always the length of 1 byte.

The following illustration shows the setting options at the ETS-Software for activating the scene function:

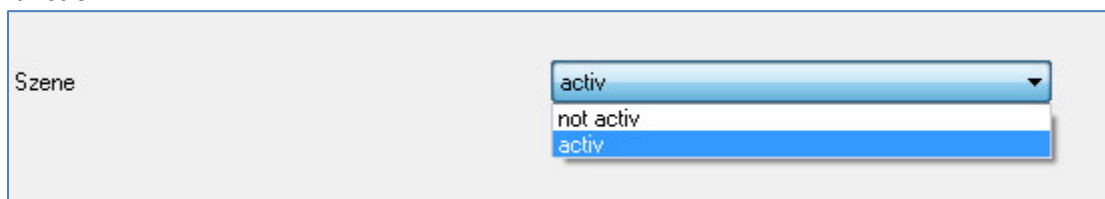

Figure 16: Scene function

The following chart shows the relevant communication object:

Number	Name	Length	Usage
4	Scene	1 Byte	Call of the scene

Table 17: Communication object scene

For calling a certain scene, you have to send the value for the scene to the communication object. The value of the scene number is always one number less than the adjusted scene number. For calling scene 1, you have to send a "0". So the scene numbers have the numbers from 1 to 64, but the values for the scenes only from 0 to 63.

If you want to call scenes by a binary input or another KNX device, you have to set the same number at the calling device as at the receiving device. The calling device, e.g. a binary input, sends automatically the right value for calling the scene.

There are up to 8 storage options for scenes at every channel.
 These 8 storage options can get any of the possible 64 scene numbers.

Channel A, Scene	
Save scene	enabled
Scene A	Off
Scene Number A	1
Scene B	Off
Scene Number B	2
Scene C	Off
Scene Number C	3
Scene D	Off
Scene Number D	4
Scene E	Off
Scene Number E	5
Scene F	Off
Scene Number F	6
Scene G	Off
Scene Number G	7
Scene H	Off
Scene Number H	8

Figure 17: Sub function scene

Technical Manual Switch Actuators AKI/AKS/AKK

The chart shows the possible settings for scenes, which are identical for all channels. The settings are available at the sub menu for the scenes:

ETS-text	Dynamic range [default value]	comment
Save scene	<ul style="list-style-type: none"> ▪ not active ▪ active ▪ keep lerned scenes (no absorption of parameters) 	Learning of scenarios; activate/deactivate memory function; The Parameter "keep lerned scenes" holds the saved scenes also after a new download of the parameter.
Scene A	<ul style="list-style-type: none"> ▪ Off ▪ On ▪ lock ▪ unlock 	Activation of the scene A
Scene number A	1-64 [1]	Scene number; Calling value = 1 less than the adjusted scene number

Table 18: Parameter scene

For calling a scene or saving a new value for the scene, you have to send the accordingly code to the relevant communication object for the scene:

Scene	Retrieve		Save	
	Hex.	Dez.	Hex.	Dez.
1	0x00	0	0x80	128
2	0x01	1	0x81	129
3	0x02	2	0x82	130
4	0x03	3	0x83	131
5	0x04	4	0x84	132
6	0x05	5	0x85	133
7	0x06	6	0x86	134
8	0x07	7	0x87	135
9	0x08	8	0x88	136
10	0x09	9	0x89	137
11	0x0A	10	0x8A	138
12	0x0B	11	0x8B	139
13	0x0C	12	0x8C	140
14	0x0D	13	0x8D	141
15	0x0E	14	0x8E	142
16	0x0F	15	0x8F	143
17	0x10	16	0x90	144
18	0x11	17	0x91	145
19	0x12	18	0x92	146
20	0x13	19	0x93	147
21	0x14	20	0x94	148
22	0x15	21	0x95	149
23	0x16	22	0x96	150
24	0x17	23	0x97	151
25	0x18	24	0x98	152
26	0x19	25	0x99	153
27	0x1A	26	0x9A	154
28	0x1B	27	0x9B	155
29	0x1C	28	0x9C	156

Table 19: Calling and saving scenes

4.3.10 Threshold switch not available at AKK Series

The threshold switch enables switching according to an analogue value. The following settings are available:

Value setting	1Byte value (0-255) ▼
Behavior of Channel at lower deviation	Off ▼
Lower threshold <	0 ▲▼
Behavior of Channel at exceedance	On ▼
Upper threshold >	0 ▲▼

Figure 18: Threshold switch

The following data point types can be evaluated with the threshold switch:

- 1 Byte percent value (0-100%) – DPT 5.001
- 1 Byte value (0-255) – DPT 5.004
- 2 Byte value (0-65500) – DPT 7.001
- 2 Byte temperature value (-100-250°C) – DPT 9.001
- 2 Byte brightness value (0-100000Lux) – DPT 9.004

A lower and an upper threshold can be set for the threshold switch at which actions can be caused. For example, a channel can be switched on at an adjusted brightness for controlling a shading. The following table shows the communication object:

Number	Name	Length	Usage
11	Threshold Switch	1/2 Byte	Receiving an analogue value for the threshold switch

Table 20: Communication object threshold switch

4.3.11 Operating hours counter not available at AKK Series

If the operating hours counter is activated, a submenu appears where the operating hours counter can be parameterized:

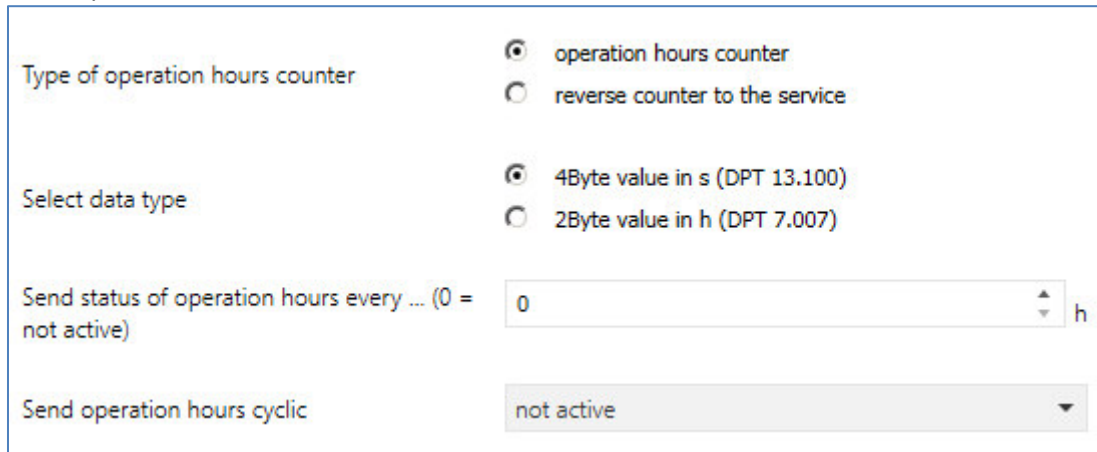

Figure 19: Operating hours counter

Two operating modes are available:

- **Operation hours counter**
The operation hours counter counts up the operation hours when the relay is closed.
- **Reverse counter to service**
The reverse counter to service counts from the adjusted service interval to zero when the relay is closed and reports a service message at ero.

The data type can be selected for each mode:

- DPT 13.100 – Value in seconds
- DPT 7.007 – Value in hours

At the operating mode “**Operation hours counter**” the following settings are available:

- **Send status of operation hours every ...h**
Setting a sending interval - in full hours – when the operation hours are sent.
- **Send operation hours cyclic**
Enables cyclic sending with smaller time intervals.

The following communication objects are available for this operation mode:

Number	Name	Length	Usage
2	Response operating hours	2/4 Byte	Sending the operation hours
3	Reset operation hours	1 Bit	Reset the operation hours

Table 21: Communication objects Operation hours counter

At the operation mode “**Reverse counter to service**” the following settings are available:

Bei der Betriebsart „**Rückwärtszähler bis zum Service**“ ist des Weiteren folgendes einzustellen:

- **Send status of service hours every ...h**
Setting a sending interval - in full hours – when the service hours are sent.
- **Send service status at intervals**
Adjusting the service interval to be counted down from.

The following communication objects are available for this operation mode:

Number	Name	Length	Usage
1	Service required	1 Bit	Reporting a pending service
2	Time until the next service	2/4 Byte	Sending of the remaining service hours
3	Reset service	1 Bit	Reset of the service hours to the adjusted value in the parameter (Send service status at intervals)

Table 22: Communication objects reverse counter to service

4.3.12 Diagram switching output

The following diagram shows the eradication of a switching command. The functions, which are nearest to the end (switch relay), have the highest priority.

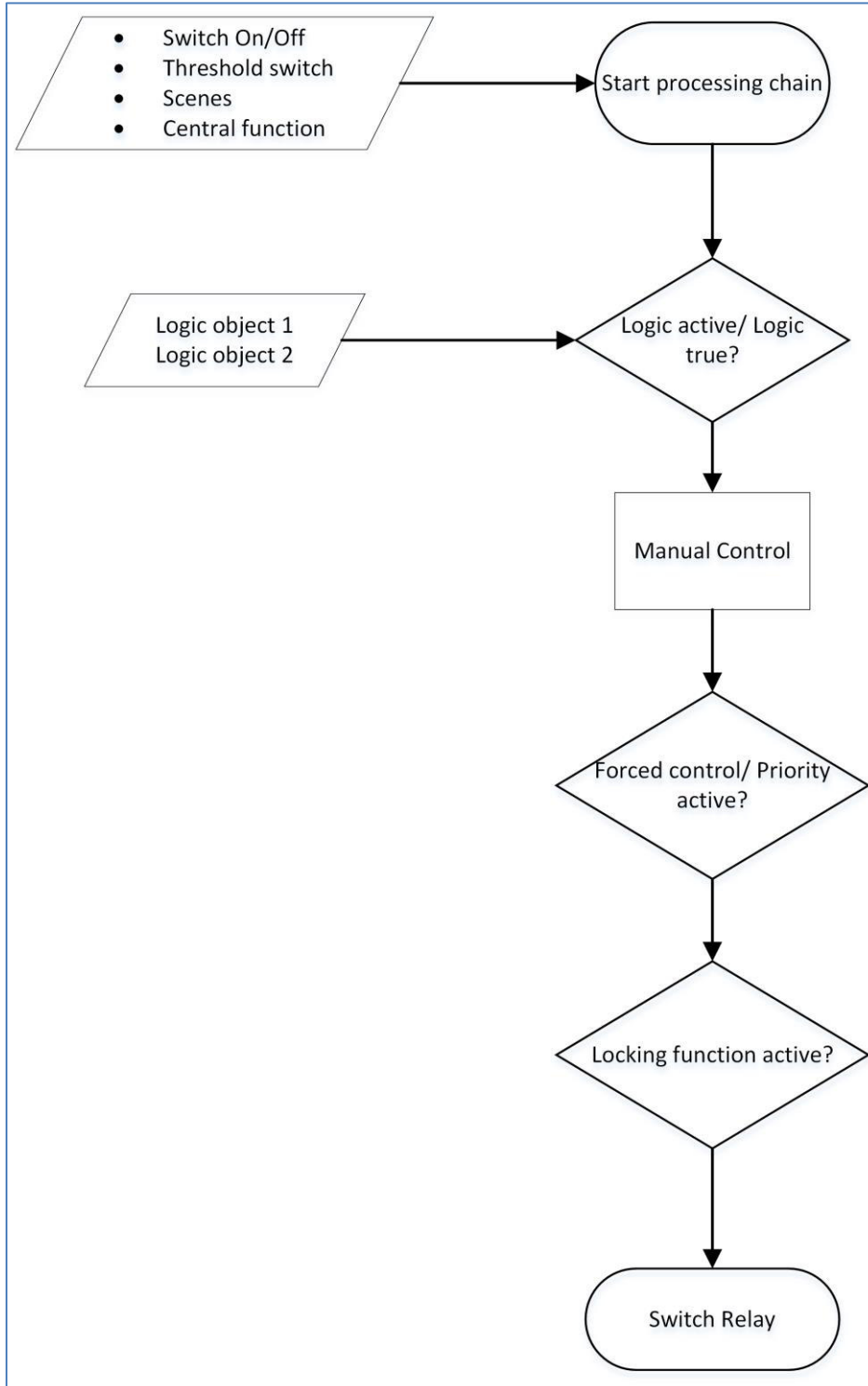

Figure 20: Diagram switching output

4.4 Staircase light

The staircase light function enables automatic off-switching of the channel after a parameterized time.

4.4.1 Relay operating mode

The following illustration shows the setting options for this parameter:

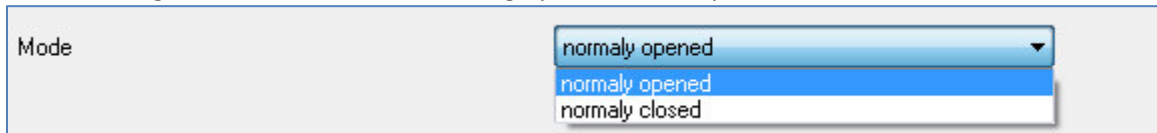

Figure 21: Operating mode

The following chart shows the dynamic range for this parameter:

ETS-text	Dynamic range [default value]	comment
Mode	<ul style="list-style-type: none"> ▪ normally opened ▪ normally closed 	Relay operating mode of the channel

Table 23: Operating mode

The following diagram shows the behavior of the relay operating mode normally closed and normally opened. The input for the channels is a KNX-telegram, which sends alternating 0-signals and 1-signals:

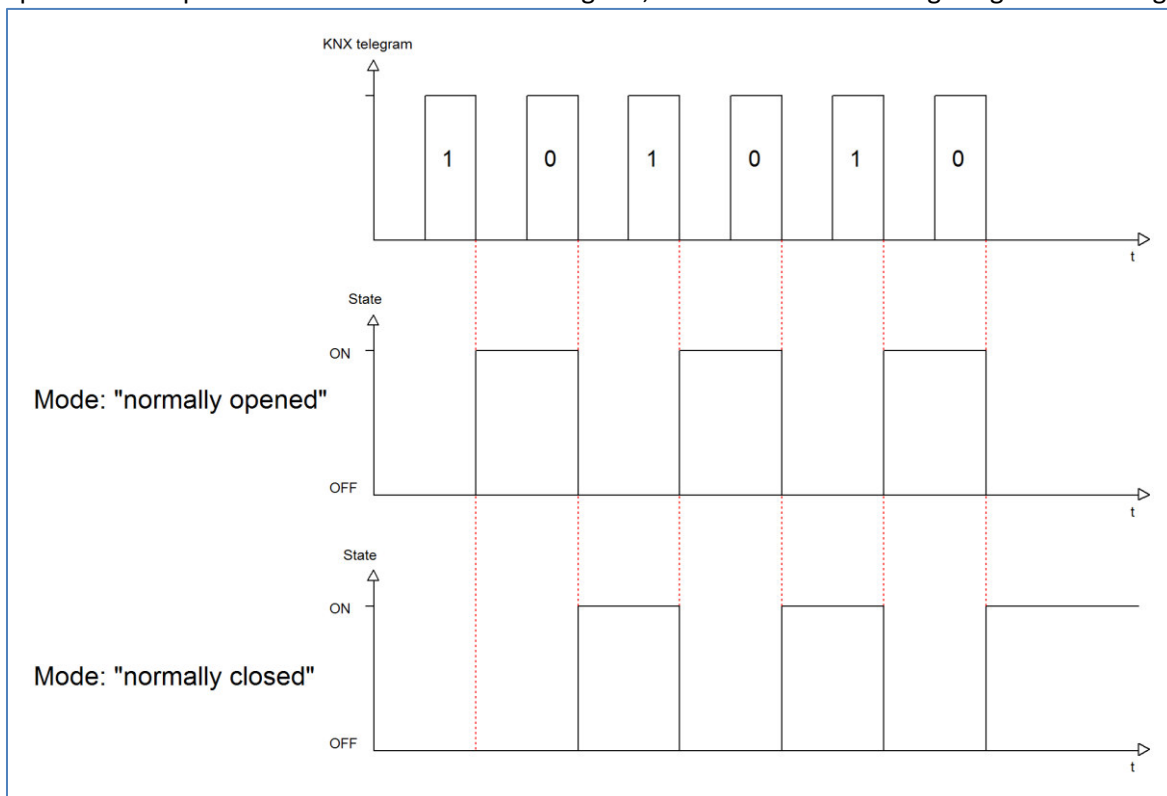

4.4.2 Central function

The following illustration shows the setting options at the ETS-Software:

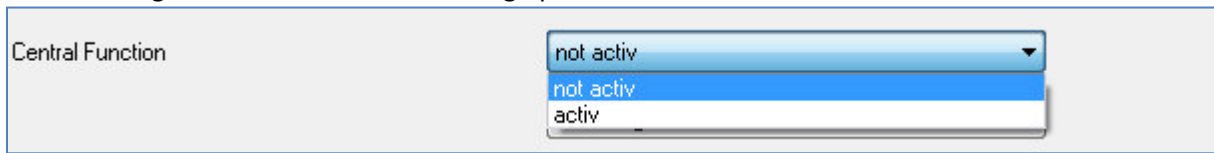

Figure 22: Central function

The following chart shows the dynamic range for this parameter:

ETS-text	Dynamic range [default value]	comment
Central function	<ul style="list-style-type: none"> ▪ not active ▪ active 	switches the central function on/off for this channel

Table 24: Central function

The central function can be switched on/off for every channel. For switching on this function, you have to choose the option “active”. By calling the central communication object, all channels with an activated central function are switched on with their current parameterization. So switch-on delays or staircase functions are still kept.

The central function can make programming much more easier and your project can become more clear.

The following chart shows the associated communication object:

Number	Name	Length	Usage
	Central function	1 Bit	central switching of the channels

Table 25: Communication object central function

4.4.3 Behavior at locking/unlocking

The following figure shows the available settings:

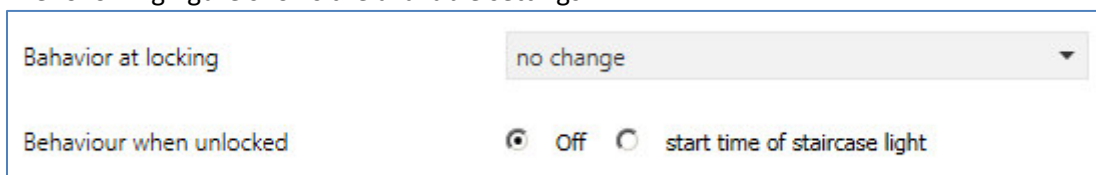

Figure 23: Locking function

The following table shows the available settings:

ETS-text	Dynamic range [default value]	comment
Behavior at locking	<ul style="list-style-type: none"> ▪ On ▪ Off ▪ no change 	Behavior at activating the locking function
Behavior at unlocking	<ul style="list-style-type: none"> ▪ Off ▪ start time of staircase light 	Behavior at deactivating the locking function

Table 26: Behavior at locking/unlocking

A Channel is locked by sending a logical 1 to the locking object and further control is no longer available as long as the channel is locked. By sending a logical 0 the channel can be unlocked again.

The following actions can be performed at locking/unlocking:

- **no change**
The channel stays in the current state.
- **On**
The channel is switched on.
- **Off**
The channel is switched off.
- **start time of staircase light**
The channel is switched on for the time of the staircase light.

The following table shows the communication object:

Number	Name	Length	Usage
4	Lock	1 Bit	Object for locking the channel

Table 27: Communication object locking function

4.4.4 Behavior at bus power down/bus power up

The following figure shows the available settings:

Behaviour at bus power up State before bus power down ▼

Behaviour at bus power down no change ▼

Figure 24: Behavior at bus power down/bus power up

The following table shows the available settings:

ETS-text	Dynamic range [default value]	comment
Behavior at bus power up	<ul style="list-style-type: none"> ▪ Off ▪ start time of staircase light ▪ State before bus power down 	Defines the behavior after bus power returns
Behavior at bus power down	<ul style="list-style-type: none"> ▪ Off ▪ On ▪ no change 	Defines the behavior when bus power is down

Table 28: Behavior at bus power down/up

The following actions can be performed at locking/unlocking:

- **no change**
The channel stays in the current state.
- **On**
The channel is switched on.
- **Off**
The channel is switched off.
- **start time of staircase light**
The channel is switched on for the time of the staircase light.
- **State before bus power down**
The state before bus power crashes down is restored.

4.4.5 State functions

The following figure shows the available state functions:

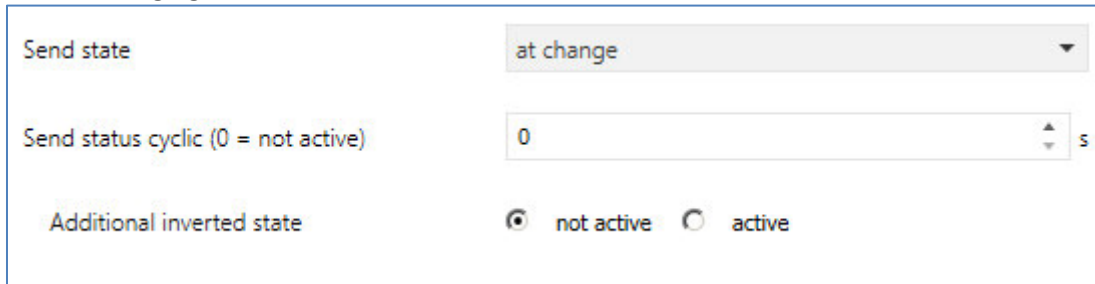

The screenshot shows a configuration interface for state functions. It includes three main sections:

- Send state:** A dropdown menu currently set to "at change".
- Send status cyclic (0 = not active):** A numeric input field set to "0" with a unit "s" (seconds) to its right.
- Additional inverted state:** Two radio buttons labeled "not active" (which is selected) and "active".

Figure 25: State functions

The following settings are available:

ETS-text	Dynamic range [default value]	comment
Send state	<ul style="list-style-type: none"> ▪ no send, passive state object ▪ at change ▪ at change and lock ▪ always at input of telegram 	Sending behavior of the state object
Send state cyclic (0 = not active)	0-30000s [0s]	Cyclic sending of the state
Additional inverted state	<ul style="list-style-type: none"> ▪ not active ▪ active 	Displaying an additional inverted state

Table 29: State functions

The following sending behavior for the state is available:

- **no send, passive state object**
The state object does not send its current state and can only be requested.
- **at change**
The state object sends its current state at every change of the output.
- **at change and lock**
The state object sends its current state at every change of the output – also during the locking process. By sending the status during the locking is ensured that a switch after locking sends the correct value.
- **always at input of telegram**
The state is sent at every input of a telegram – independent whether the output is changed or not.

The additional inverted state can be used for visualization, etc. and has always the opposite value of the “normal” state.

The following table shows the communication objects:

Number	Name	Length	Usage
7	State	1 Bit	Sends the state of the channel
8	inverted state	1 Bit	Sends the inverted state of the channel

Table 30: Communication objects state function

4.4.6 Priority/Forced control

not available at AKK Series

The following figure shows the parameter priority/forced control:

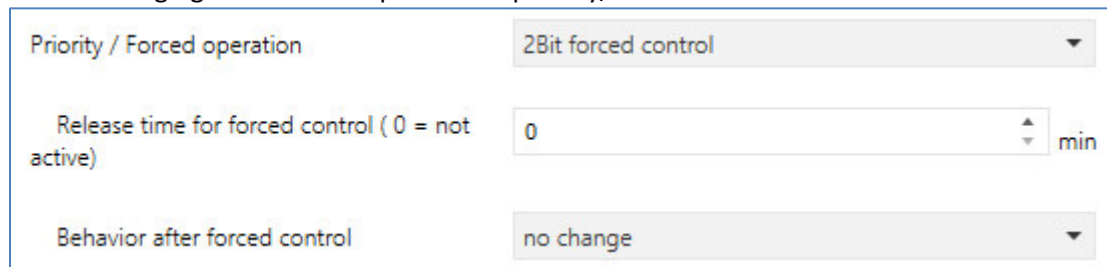

Figure 26: Priority/Forced control

The following settings are available:

ETS-text	Dynamic range [default value]	comment
Priority/Forced Control	<ul style="list-style-type: none"> ▪ not active ▪ 2 Bit forced control ▪ 1 Bit priority ON ▪ 1 Bit priority OFF 	Activation of the forced control/priority function
Release time for forced control (0 = not active)	0-600min [0 min]	Activation of a release time from the priority/forced control into the normal state.
Behavior after forced control/priority	<ul style="list-style-type: none"> ▪ Off ▪ no change ▪ start time of staircase light 	Setting of the behavior after deactivating priority/forced control.

Table 31: Priority/Forced control

The priority/forced operation cause the priority switching of output. By using the release time, the priority/forced control can be deactivated automatically and the channel changes into the normal state.

The followings actions can be performed after deactivating the priority/forced control:

- **Off**
The channel is switched off.
- **start time of staircase light**
The channel is switched on for the time of the staircase light.

The following table shows the communication object:

Number	Name	Length	Usage
5	Forced control/Priority	1 Bit	Activation/Deactivation of the forced control/priority

Table 32: Communication object priority/forced control

4.4.7 Scenes

When functions of different groups (e.g. light, heating and shutter) shall be changed simultaneously with only one keystroke, it is practical to use the scene function. By calling a scene, you can switch the lights to a specific value, drive the shutter to an absolute position, switch the heating to the day mode and switch the power supply of the sockets on. The telegrams of these functions can have as well different formats as different values with different meaning (e.g. "0" for switch the lights off and open the shutters). If there were no scene function, you would have to send a single telegram for every actuator to get the same function.

The scene function of the switch actuator enables you to connect the channels of the switch actuator to a scene control. For that, you have to assign the value to the appropriated space (scene A..H). It is possible to program up to 8 scenes per switching output. When you activate the scene function at the switching output, a new sub menu for the scenes appears at the left drop down menu. There are settings to activate single scenes, set values and scene numbers and switch the memory function on/off at this sub menu.

Scenes are activated by receiving their scene numbers at the communication object for the scenes. If the memory function of the scenes is activated, the current value of the channel will be saved at the called scene number.

The communication objects of the scenes have always the length of 1 byte.

The following illustration shows the setting options at the ETS-Software for activating the scene function:

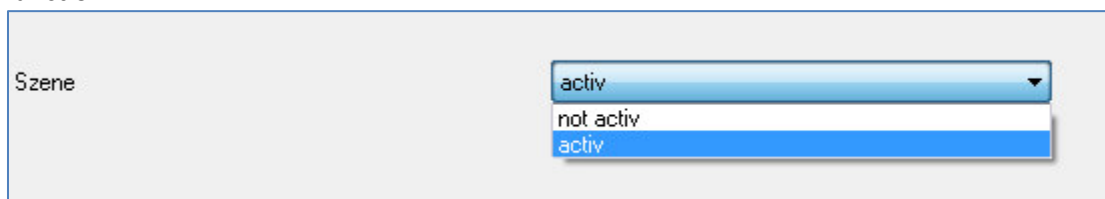

Figure 27: Scene function

The following chart shows the relevant communication object:

Number	Name	Length	Usage
4	Scene	1 Byte	Call of the scene

Table 33: Communication object scene

For calling a certain scene, you have to send the value for the scene to the communication object. The value of the scene number is always one number less than the adjusted scene number. For calling scene 1, you have to send a "0". So the scene numbers have the numbers from 1 to 64, but the values for the scenes only from 0 to 63.

If you want to call scenes by a binary input or another KNX device, you have to set the same number at the calling device as at the receiving device. The calling device, e.g. a binary input, sends automatically the right value for calling the scene.

There are up to 8 storage options for scenes at every channel.
 These 8 storage options can get any of the possible 64 scene numbers.

Channel A, Scene	
Save scene	enabled
Scene A	Off
Scene Number A	1
Scene B	Off
Scene Number B	2
Scene C	Off
Scene Number C	3
Scene D	Off
Scene Number D	4
Scene E	Off
Scene Number E	5
Scene F	Off
Scene Number F	6
Scene G	Off
Scene Number G	7
Scene H	Off
Scene Number H	8

Figure 28: Sub function scene

Technical Manual Switch Actuators AKI/AKS/AKK

The chart shows the possible settings for scenes, which are identical for all channels. The settings are available at the sub menu for the scenes:

ETS-text	Dynamic range [default value]	comment
Save scene	<ul style="list-style-type: none"> ▪ not active ▪ active ▪ keep lerned scenes (no absorption of parameters) 	Learning of scenarios; activate/deactivate memory function; The Parameter "keep lerned scenes" holds the saved scenes also after a new download of the parameter.
Scene A	<ul style="list-style-type: none"> ▪ Off ▪ On ▪ lock ▪ unlock 	Activation of the scene A
Scene number A	1-64 [1]	Scene number; Calling value = 1 less than the adjusted scene number

Table 34: Parameter scene

For calling a scene or saving a new value for the scene, you have to send the accordingly code to the relevant communication object for the scene:

Scene	Retrieve		Save	
	Hex.	Dez.	Hex.	Dez.
1	0x00	0	0x80	128
2	0x01	1	0x81	129
3	0x02	2	0x82	130
4	0x03	3	0x83	131
5	0x04	4	0x84	132
6	0x05	5	0x85	133
7	0x06	6	0x86	134
8	0x07	7	0x87	135
9	0x08	8	0x88	136
10	0x09	9	0x89	137
11	0x0A	10	0x8A	138
12	0x0B	11	0x8B	139
13	0x0C	12	0x8C	140
14	0x0D	13	0x8D	141
15	0x0E	14	0x8E	142
16	0x0F	15	0x8F	143
17	0x10	16	0x90	144
18	0x11	17	0x91	145
19	0x12	18	0x92	146
20	0x13	19	0x93	147
21	0x14	20	0x94	148
22	0x15	21	0x95	149
23	0x16	22	0x96	150
24	0x17	23	0x97	151
25	0x18	24	0x98	152
26	0x19	25	0x99	153
27	0x1A	26	0x9A	154
28	0x1B	27	0x9B	155
29	0x1C	28	0x9C	156

Table 35: Calling and saving scenes

4.4.8 Staircase with variable time not available at AKK Series

The following parameters are available for a variable staircase time:



Time factor for object "Staircase light with time" 1 s

Figure 29: Parameter variable staircase time

The variable staircase time allows starting the staircase with a variable time. For this purpose, a value of 0-255 to 1 byte input is sent. The resulting staircase lighting time is calculated as:

sent value x adjusted time factor = staircase time

If a value of 10s is set and the value 55 is sent, the staircase light is started with a time of 550seconds.

The variable staircase time can be used for starting the staircase time in a big staircase at every floor with an individual staircase time.

The following table shows the available communication object:

Number	Name	Length	Usage
2	Staircase light with time	1 Byte	Starting of the variable staircase time

Table 36: variable staircase time

4.4.9 Prewarning function

The following figure shows the available settings for the prewarning function:

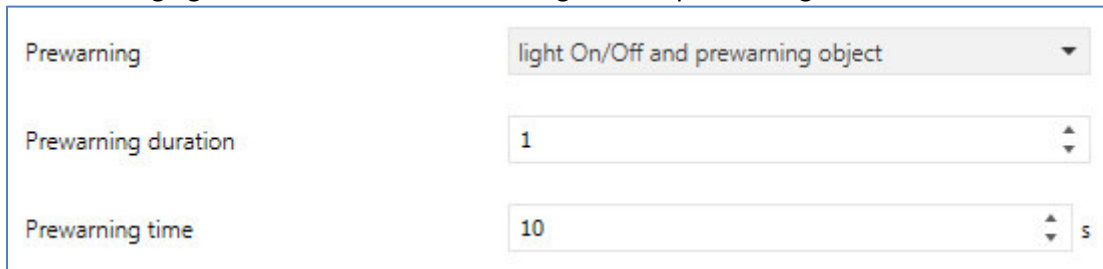

Prewarning light On/Off and prewarning object

Prewarning duration 1

Prewarning time 10 s

Figure 30: Prewarning function

The prewarning function warns

The warning function warns you before running out of the staircase time (and thus turning off the channel).

The following table shows the available settings:

ETS-text	Dynamic range [default value]	comment
Prewarning	<ul style="list-style-type: none"> ▪ not active ▪ Light On/Off ▪ prewarning object ▪ light On/Off and prewarning object 	Setting of the prewarning function
Prewarning duration	0-30.000 [1]	Setting the prewarning duration = the time for which the light is switched off; only available at the functions with "light On/Off"
Prewarning time	0-30.000 [10]	Setting the prewarning time = the time for which the prewarning object sends a „1“ or the light is switched on again

Table 37: Prewarning function

The settings for the warning have the following behavior:

- **Light On/Off**
The light is switched off, for the adjusted prewarning duration, after the staircase time runs out. Afterwards the light is switched on again for the adjusted prewarning time.
- **Prewarning object**
An additional communication object for the prewarning function is shown. This object sends a „1“ after the staircase time runs out, but the light stays on. After the prewarning time, the channel is switched off and the object sends a “0”. So, by using this function, the whole staircase time is extended by the adjusted prewarning time.
- **Light On/Off and prewarning object**
A combination of both settings.

The following table shows the available communication object:

Number	Name	Length	Usage
3	Prewarning	1 Bit	Sending a prewarning before the staircase time runs out.

Table 38: Prewarning object

4.4.10 Manual switch off

The following illustration shows the setting options at the ETS-Software:



Figure 31: Manual switch off

By activation this function, you can switch the channel off before the staircase time runs out. For switching off the channel, you have to send a logical “0” to the communication object for switching the staircase function. When this function is not activated, the channel switches only off after the staircase time runs out.

4.4.11 Extend time of staircase light

The following figure shows the available settings:

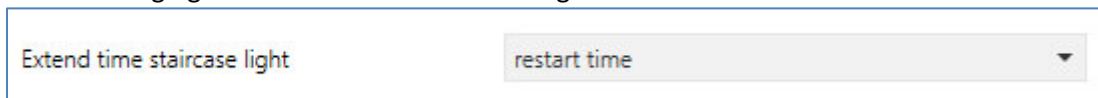

Figure 32: Extend time of staircase light

The following table shows the available settings:

ETS-text	Dynamic range [default value]	comment
Extend time of staircase light	<ul style="list-style-type: none"> ▪ no extend time ▪ restart time ▪ add time 	Setting if the staircase light can be extended.

Table 39: Extend time of staircase light

The settings have the following functions:

- **No extend time**
The staircase time cannot be extended. It is only possible to restart the staircase time after it runs out.
- **Restart time**
The staircase time is restarted by sending an “on-signal” to the communication object “staircase light”.
- **Add time**
The staircase time is added to the remaining staircase time when a new “on-signal” is sent to the communication object “staircase light”.

The following diagram shows the behavior of the setting “restart time”:

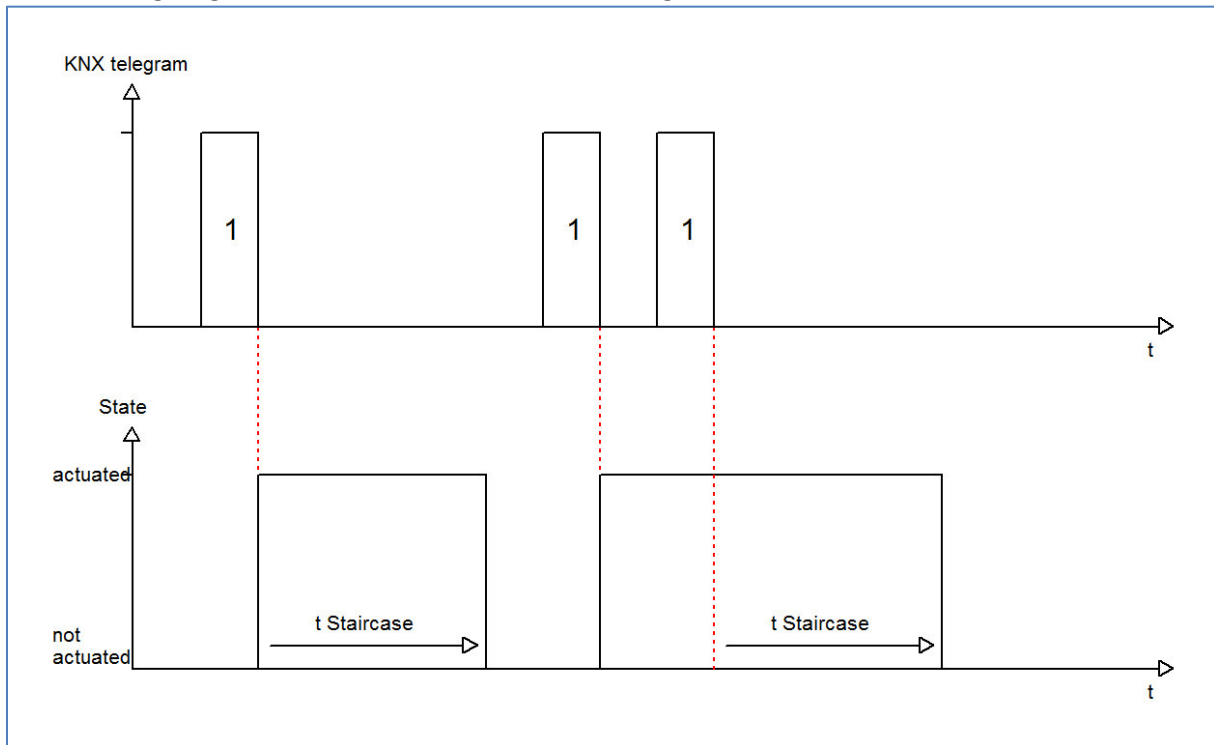

4.4.12 Additional switching object

The following figure shows the available settings:



Figure 33: Additional switching object

By activating the switch object, an additional switching object is shown, which works independently from the staircase light. The switching object switches the channel permanently on/off and does not operate with the staircase time.

The following table shows the available communication object:

Number	Name	Length	Usage
0	Switch On/Off	1 Bit	additional switching object

Table 40: Additional switching object

4.5 Switch pulse

The function switch pulse can be used for generating a short switch pulse.

4.5.1 Relay operating mode

The following illustration shows the setting options for this parameter:

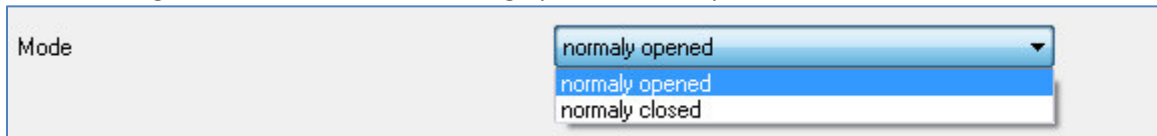

Figure 34: Operating mode

The following chart shows the dynamic range for this parameter:

ETS-text	Dynamic range [default value]	comment
Mode	<ul style="list-style-type: none"> ▪ normally opened ▪ normally closed 	Relay operating mode of the channel

Table 41: Operating mode

The following diagram shows the behavior of the relay operating mode normally closed and normally opened. The input for the channels is a KNX-telegram, which sends alternating 0-signals and 1-signals:

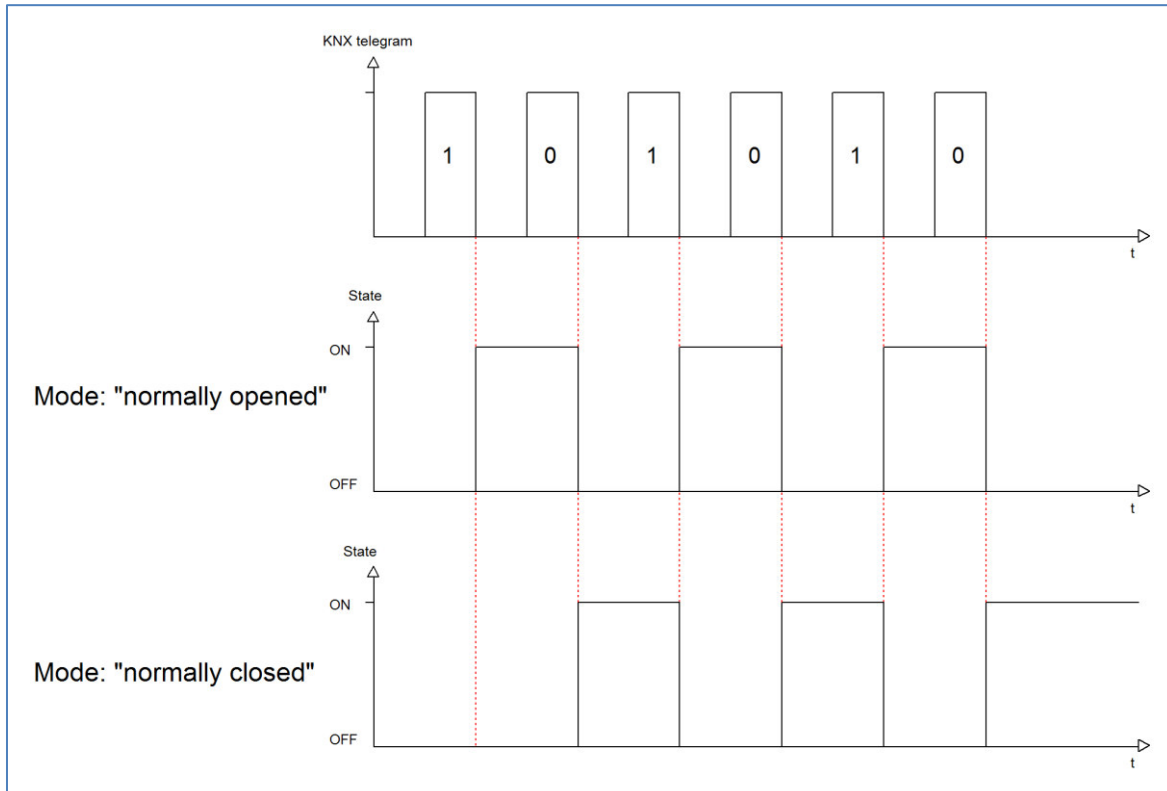

4.5.2 Pulse function

The following figure shows the available settings for the pulse function:

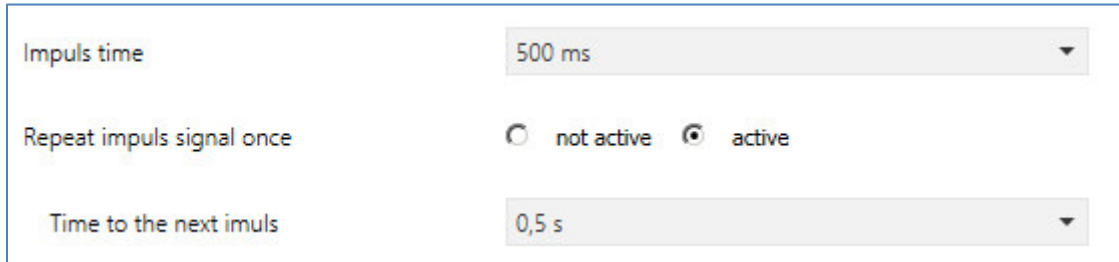

Figure 35: Pulse function

The following table shows the available settings:

ETS-text	Dynamic range [default value]	comment
Pulse time	300ms – 30s [500ms]	Setting of the duration of the pulse
Repeat pulse signal once	<ul style="list-style-type: none"> • not active • active 	Setting if the pulse is repeated once
Time to next pulse	0,5s – 30s [0,5s]	Setting of the duration between the first and the second pulse; is only shown when the pulse signal is repeated.

Table 42: Pulse function

The following table shows the available communication object:

Number	Name	Length	Usage
1	Switch pulse	1 Bit	Starting the pulse

Table 43: Communication object pulse function

4.5.3 Locking function

The following figure shows the available settings for the locking function:

Behavior at locking	<input type="radio"/> Off	<input checked="" type="radio"/> no change
Behaviour when unlocked	<input checked="" type="radio"/> Off	<input type="radio"/> switch impulse

Figure 36: Locking function

The following table shows the available settings for the locking function:

ETS-text	Dynamic range [default value]	comment
Behavior at locking	<ul style="list-style-type: none"> ▪ Off ▪ no change 	Behavior at activating the locking function
Behavior at unlocking	<ul style="list-style-type: none"> ▪ Off ▪ Switch pulse 	Behavior at deactivating the locking function

Table 44: Locking function

A Channel is locked by sending a logical 1 to the locking object and further control is no longer available as long as the channel is locked. By sending a logical 0 the channel can be unlocked again.

The following actions can be performed at locking/unlocking:

- **no change**
The channel stays in the current state.
- **On**
The channel is switched on.
- **Off**
The channel is switched off.
- **switch pulse**
The channel generates the switch pulse as parameterized.

The following table shows the available communication object:

Number	Name	Length	Usage
4	Lock	1 Bit	Object for activating/deactivating the locking function

Table 45: Communication object locking function

5 Index

5.1 Register of illustrations

Figure 1: Exemplary circuit diagram AKI-0816.03	5
Figure 2: Exemplary circuit diagram AKS-0816.03	6
Figure 3: Exemplary circuit diagram AKK-0816.03	6
Figure 4: Structure & Handling – here AKI-0816.03	7
Figure 5: General settings.....	16
Figure 6: Channel selection	17
Figure 7: Operating mode	18
Figure 8: Central function.....	19
Figure 9: Behavior at locking/unlocking	19
Figure 10: Behavior at bus power down/up.....	20
Figure 11: On/Off delay.....	21
Figure 12: State functions	22
Figure 13: Priority/Forced control.....	23
Figure 14: Logic functions.....	24
Figure 15: Logic function -> schematic diagram.....	24
Figure 16: Scene function.....	26
Figure 17: Sub function scene	27
Figure 18: Threshold switch	29
Figure 19: Operating hours counter	30
Figure 20: Diagram switching output	32
Figure 21: Operating mode	33
Figure 22: Central function.....	34
Figure 23: Locking function	34
Figure 24: Behavior at bus power down/bus power up.....	35
Figure 25: State functions	36
Figure 26: Priority/Forced control.....	38
Figure 27: Scene function.....	39
Figure 28: Sub function scene	40
Figure 29: Parameter variable staircase time	42
Figure 30: Prewarning function.....	42
Figure 31: Manual switch off.....	44
Figure 32: Extend time of staircase light	44
Figure 33: Additional switching object.....	45
Figure 34: Operating mode	46
Figure 35: Pulse function.....	47
Figure 36: Locking function	48

5.2 List of tables

Table 1: Overview functions.....	9
Table 2: Communication Objects	14
Table 3: Communication objects – default settings.....	15
Table 4: General settings.....	16
Table 5: Channel selection	17
Table 6: Operating mode.....	18
Table 7: Central function.....	19
Table 8: Communication object central function.....	19
Table 9: Behavior at locking/unlocking	20
Table 10: Communication object for locking/unlocking	20
Table 11: Behavior at bus power down/up.....	21
Table 12: State functions.....	22
Table 13: Communication objects state function	22
Table 14: Priority/Forced control	23
Table 15: Communication object priority/forced control	23
Table 16: Communication objects logic	25
Table 17: Communication object scene	26
Table 18: Parameter scene.....	28
Table 19: Calling and saving scenes.....	28
Table 20: Communication object threshold switch.....	29
Table 21: Communication objects Operation hours counter.....	30
Table 22: Communication objects reverse counter to service.....	31
Table 23: Operating mode.....	33
Table 24: Central function.....	34
Table 25: Communication object central function.....	34
Table 26: Behavior at locking/unlocking	35
Table 27: Communication object locking function.....	35
Table 28: Behavior at bus power down/up.....	36
Table 29: State functions.....	37
Table 30: Communication objects state function	37
Table 31: Priority/Forced control	38
Table 32: Communication object priority/forced control	38
Table 33: Communication object scene	39
Table 34: Parameter scene.....	41
Table 35: Calling and saving scenes.....	41
Table 36: variable staircase time.....	42
Table 37: Prewarning function	43
Table 38: Prewarning object	43
Table 39: Extend time of staircase light	44
Table 40: Additional switching object	45
Table 41: Operating mode.....	46
Table 42: Pulse function	47
Table 43: Communication object pulse function	47
Table 44: Locking function.....	48
Table 45: Communication object locking function.....	48

6 Attachment

6.1 Statutory requirements

The above-described devices must not be used with devices, which serve directly or indirectly the purpose of human, health- or lifesaving. Further the devices must not be used if their usage can occur danger for humans, animals or material assets.

Do not let the packaging lying around careless, plastic foil/ -bags etc. can be a dangerous toy for kids.

6.2 Routine disposal

Do not throw the waste equipment in the household rubbish. The device contains electrical devices, which must be disposed as electronic scrap. The casing contains of recyclable synthetic material.

6.3 Assemblage



Risk for life of electrical power!

All activities on the device should only be done by an electrical specialist. The county specific regulations and the applicable EIB-directives have to be observed.

6.4 History

- Version 1.0 - First version of the manual for the third generation of the switch actuators
- Version 1.1 - New devices (AKS-1616.03 und third generation of series AKK) added
- Version 1.2 - Description of scenes revised

6.5 Datasheet

MDT Switch Actuator 4/8/12-fold, MDRC

Version		
AKI-0416.03	Switch Actuator 4-fold	4SU MDRC, 230VAC, 16/20A, C-Load 200uF
AKI-0816.03	Switch Actuator 8-fold	8SU MDRC, 230VAC, 16/20A, C-Load 200uF
AKI-1216.03	Switch Actuator 12-fold	12SU MDRC, 230VAC, 16/20A, C-Load 200uF

The MDT Switch Actuator receives KNX/EIB telegrams and switches up to 12 independent electrical loads. Each output uses a bistable relay and can be operated manually via a push button. A green LED indicates the switching status of each channel. The MDT Switch Actuator is suitable for extreme high inrush currents and used for heavy loads (C-Load).

The outputs are parameterized individually via ETS. The device provides extensive functions like logical operation, status response, block functions, central function, delay functions and staircase lighting function. Additionally the device provides several time and scene control. If the mains voltage fails, all outputs hold their current position. After bus voltage failure or recovery the relay position is selected in dependence on the parameterization.

The MDT Switch Actuator has separate power supply terminals for each channel. It is a modular installation device for fixed installation in dry rooms. It fits on DIN 35mm rails in power distribution boards or closed compact boxes.

For project design and commissioning of the MDT Switch Actuator it is recommended to use the ETS or later. Please download the application software at www.mdt.de/Downloads.html

AKI-0816.03



AKI-1216.03



- Production in Germany, certified according to ISO 9001
- **Extensive function extension**
- **Lockable manual operation and LED indicator for each channel**
- NO and NC contact operation
- Status response at manually operation
- Time functions (switch-on/switch-off delay)
- Extensive staircase light and impulse functions
- Extended logical and scene functions for each channel
- Extended status functions (inverted, cyclic, at block)
- **Threshold switch (Byte/2Byte/2Byte float)**
- **Hour meter for switching**
- **Priority/forced operation with automatic release time**
- Separate power supply terminals for each channel
- Power supply via KNX bus
- Quick application download (long frame support for ETS5)
- Modular installation device for DIN 35mm rails
- Integrated bus coupling unit
- 3 years warranty

Technical Data	AKI-0416.03	AKI-0816.03	AKI-1216.03
Number of outputs	4	8	12
Output switching ratings			
Ohmic load	16A/20A*	16A/20A*	16A/20A*
Capacitive load	max. 200uF at 16A	max. 200uF at 16A	max. 200uF at 16A
Voltage	230VAC	230VAC	230VAC
Maximum inrush current	600A/150µs 300A/600µs	600A/150µs 300A/600µs	600A/150µs 300A/600µs
Maximum load			
Incandescent lamps	3680W	3680W	3680W
Halogen lamps 230V	3680W	3680W	3680W
Halogen lamps, electronic transformer**	2000W	2000W	2000W
Fluorescent lamps, not compensated	3680W	3680W	3680W
Fluorescent lamps, parallel comp.	2500W	2500W	2500W
Max. number of electronic transformers	28	28	28
Output life expectancy (mechanical)	1.000.000	1.000.000	1.000.000
Specification KNX Interface	TP-256 with long frame support for ETS5		
Available application software	ETS 4/5	ETS 4/5	ETS 4/5
Permitted wire gauge			
Screw terminal	1 x 0,5 - 4,0mm ² solid core / finely stranded 2 x 0,5 - 2,5mm ² solid core / finely stranded (no mix allowed)		
KNX busconnection terminal	0,8mm Ø, solid core	0,8mm Ø, solid core	0,8mm Ø, solid core
Torque screw terminal	0,5Nm	0,5Nm	0,5Nm
Power supply	KNX bus	KNX bus	KNX bus
Power consumption KNX bus typ.	< 0,25W	< 0,25W	< 0,25W
Operation temperature range	0 to + 45°C	0 to + 45°C	0 to + 45°C
Enclosure	IP 20	IP 20	IP 20
Dimensions MDRC (Space Units)	4SU	8SU	12SU

* total current carrying capacity neighbouring outputs max. 32 A

** low voltage halogen lamps with electronic transformer

Exemplary circuit diagram AKI-0816.03

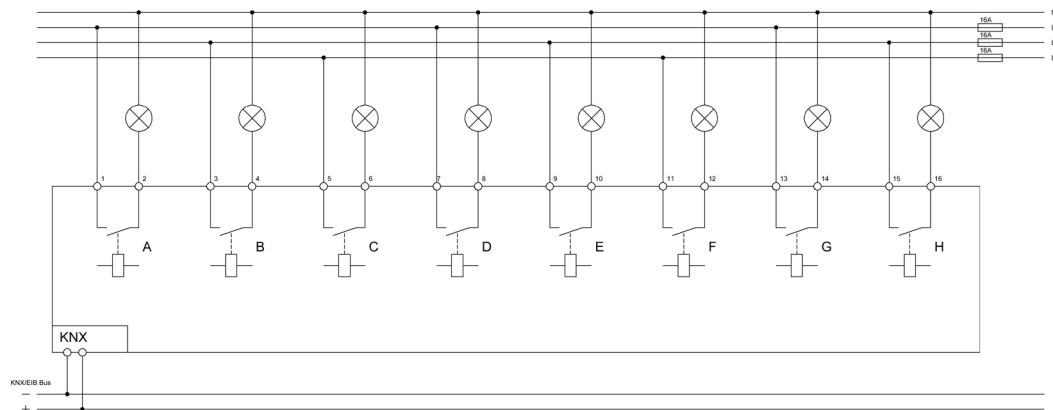

MDT Switch Actuator compact 2/4/8/16-fold, MDRC

Version		
AKK-0216.03	Switch Actuator 2-fold	2SU MDRC, 230VAC, 16A
AKK-0416.03	Switch Actuator 4-fold	2SU MDRC, 230VAC, 16A
AKK-0816.03	Switch Actuator 8-fold	4SU MDRC, 230VAC, 16A
AKK-1616.03	Switch Actuator 16-fold	8SU MDRC, 230VAC, 16A

The MDT Switch Actuator AKK receives KNX/EIB telegrams and switches up to 16 independent electrical loads . Each output uses a bistable relay and can be operated manually via a push button. The outputs are parameterized individually via ETS. The device provides extensive functions like logical operation, status response, block functions, central function, delay functions and staircase lighting function. Additionally the device provides several time and scene control.

If the mains voltage fails, all outputs were switched off. After mains voltage recovery the relay position will be restored. After bus voltage failure or recovery the relay position is selected in dependence on the parameterization. The MDRC Switch Actuators use a common power supply terminal for four channels. This feature simplifies the wiring and increases clarity of the circuit.

The MDT Switch Actuator AKK is a modular installation device for fixed installations in dry rooms. It fits on DIN 35mm rails in power distribution boards or closed compact boxes.

For project design and commissioning of the MDT Switch Actuator AKK it is recommended to use the ETS or later. Please download the application software at www.mdt.de/downloads.html

AKK-0216.03



AKK-0816.03

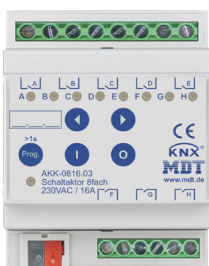

AKK-0416.03



AKK-1616.03

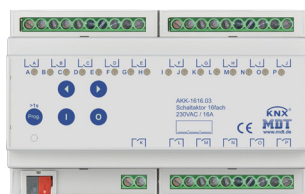

- Production in Germany, certified according to ISO 9001
- **Function extension:**
- Lockable manual operation and LED indicator for each channel
- NO and NC contact operation
- Status response after manually operation
- Time functions (switch-on/switch-off delay)
- Extensive staircase light and impulse function
- Status response (active/passive) for each channel
- Extended scene functions for each channel
- 8 scenes per channel
- Central switching functions and block functions
- Adjustable behavior in case of bus voltage failure or return
- Four contacts share one supply phase (AKK-02/0416.03)
- Each contact has an own supply phase (AKK-08/1616.03)
- Power supply via KNX bus
- Quick application download (long frame support for ETS5)
- Integrated bus coupling unit
- 3 years warranty

Technical Data	AKK-0216.03	AKK-0416.03	AKK-0816.03	AKK-1616.03
Number of outputs	2	4	8	16
Output switching ratings*				
Ohmic load	16A	16A	16A	16A
Capacitive load	70uF	70uF	70uF	70uF
Voltage	230VAC	230VAC	230VAC	230VAC
Maximum inrush current	300A/150µs 150A/600µs	300A/150µs 150A/600µs	300A/150µs 150A/600µs	300A/150µs 150A/600µs
Maximum load				
Incandescent lamps	2000W	2000W	2000W	2000W
Halogen lamps 230V	2000W	2000W	2000W	2000W
Halogen lamps, electronic transformer	1200W	1200W	1200W	1200W
Fluorescent lamps, not compensated	1800W	1800W	1800W	1800W
Fluorescent lamps, parallel comp.	800W	800W	800W	800W
Max. number of electronic transformers	10	10	10	10
Output life expectancy (mechanical)	1.000.000	1.000.000	1.000.000	1.000.000
Max. total current of the actuator	16A	16A	50A	100A
Specification KNX interface	TP-256 with long frame support for ETS5			
Available application software	ETS 4/5	ETS 4/5	ETS 4/5	ETS 4/5
Permitted wire gauge				
Screw terminal	0,5 - 2,5mm ² solid core 0,5 - 2,5mm ² finely stranded	0,5 - 4,0mm ² solid core 0,5 - 2,5mm ² finely stranded	1 x 0,5 - 4,0mm ² solid core / finely stranded 2 x 0,5 - 2,5mm ² solid core / finely stranded (no mix allowed)	
KNX busconnection terminal	0,8mm Ø, solid core	0,8mm Ø, solid core	0,8mm Ø, solid core	0,8mm Ø, solid core
Torque screw terminal	0,5Nm	0,5Nm	0,5Nm	0,5Nm
Power supply	KNX bus	KNX bus	KNX bus	KNX bus
Power consumption KNX bus	<0,3W	<0,3W	<0,3W	<0,3W
Operation temperature range	0 to +45°C	0 to +45°C	0 to +45°C	0 to +45°C
Enclosure	IP20	IP20	IP20	IP20
Dimensions MDRC (Space Units)	2SU	2SU	4SU	8SU

Exemplary circuit diagram AKK-0816.03

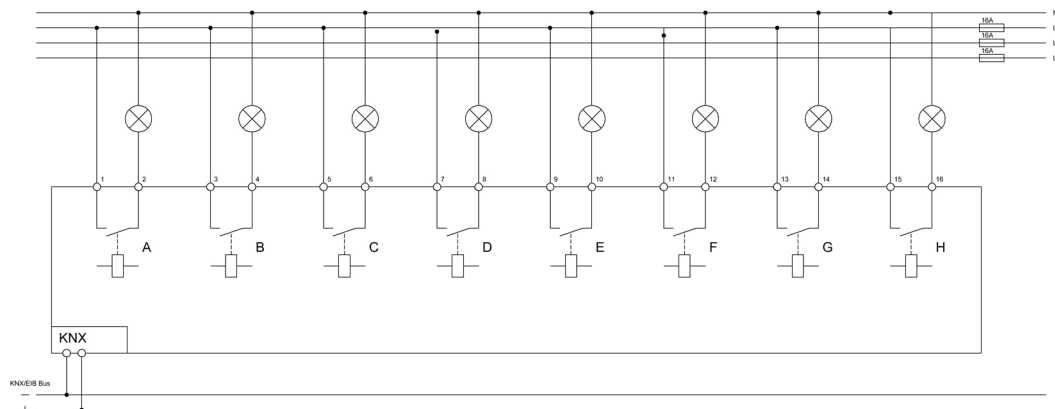

MDT Switch Actuator 4/8/12/16/20-fold, MDRC

Version		
AKS-0416.03	Switch Actuator 4-fold	4SU MDRC, 230VAC, 16A, C-Load 140uF
AKS-0816.03	Switch Actuator 8-fold	6SU MDRC, 230VAC, 16A, C-Load 140uF
AKS-1216.03	Switch Actuator 12-fold	8SU MDRC, 230VAC, 16A, C-Load 140uF
AKS-1616.03	Switch Actuator 16-fold	8SU MDRC, 230VAC, 16A, C-Load 140uF
AKS-2016.03	Switch Actuator 20-fold	12SU MDRC, 230VAC, 16A, C-Load 140uF

The new AKS series offers more channels at less space, so lower costs per channel.

The MDT Switch Actuator receives KNX/EIB telegrams and switches up to 20 independent electrical loads. Each output uses a bistable relay and can be operated manually via a push button. A green LED indicates the switching status of each channel. The MDT Switch Actuator is suitable for high inrush currents and used for heavy loads (C-Load).

The outputs are parameterized individually via ETS. The device provides extensive functions like logical operation, status response, block functions, central function, delay functions and staircase lighting function. Additionally the device provides several time and scene control. If the mains voltage fails, all outputs hold their current position. After bus voltage failure or recovery the relay position is selected in dependence on the parameterization.

The MDT Switch Actuator has separate power supply terminals for each channel and are very space saving by ideal form factor.

The MDT Switch Actuator is a modular installation device for fixed installation in dry rooms. It fits on DIN 35mm rails in power distribution boards or closed compact boxes.

For project design and commissioning of the MDT Switch Actuator it is recommended to use the ETS or later. Please download the application software at www.mdt.de/Downloads.html

AKS-0816.03

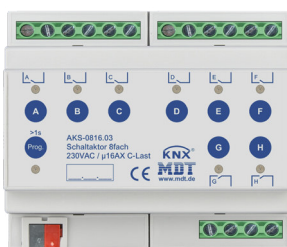

AKS-2016.03

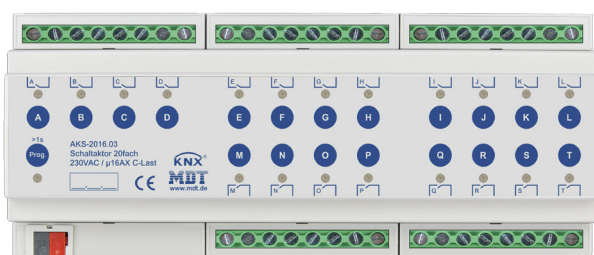

- Production in Germany, certified according to ISO 9001
- **Space saving by ideal form factor**
- **Saves up to 30% space (only AKS-2016.03)**
- **Extensive function extension**
- Lockable manual operation and LED indicator for each channel
- NO and NC contact operation
- Status response at manually operation
- Time functions (switch-on/switch-off delay, staircase light functions)
- Extended logical and scene functions for each channel
- Extended status functions (inverted, cyclic, at block)
- **Threshold switch (Byte/2Byte/2Byte float)**
- **Hour meter for switching**
- **Priority/forced operation with automatic release time**
- Separate power supply terminals for each channel
- Power supply via KNX bus
- Quick application download (long frame support for ETS5)
- Modular installation device for DIN 35mm rails
- Integrated bus coupling unit
- 3 years warranty

Technical Data	AKS-0416.03 AKS-0816.03 AKS-1216.03 AKS-1616.03 AKS-2016.03				
Number of outputs	4	8	12	16	20
Output switching ratings					
Ohmic load	16A				
Capacitive load	140µF				
Voltage	230VAC				
Maximum inrush current	600A/150µs 250A/600µs				
Maximum load					
Incandescent lamps	2500W				
Halogen lamps 230V	2500W				
Halogen lamps, electronic transformer*	1500W				
Fluorescent lamps, not compensated	2300W				
Fluorescent lamps, parallel comp.	1500W				
Max. number of electronic transformers	20				
Output life expectancy (mechanical)	1.000.000				
Max. total current of the actuator	64A	96A	128A	128A	192A
Specification KNX interface	TP-256 with long frame support for ETS5				
Available application software	ETS 4/5				
Permitted wire gauge					
Screw terminal	1 x 0,5 - 4,0mm ² solid core / finely stranded 2 x 0,5 - 2,5mm ² solid core / finely stranded (no mix allowed)				
KNX busconnection terminal	0,8mm Ø, solid core				
Torque screw terminal	0,5Nm				
Power supply	KNX bus				
Power consumption KNX bus typ.	< 0,25W	< 0,25W	< 0,3W	< 0,3W	
Operation temperature range	0 to + 45°C				
Enclosure	IP 20				
Dimensions MDRC (Space Units)	4SU	6SU	8SU	8SU	12SU

* low voltage halogen lamps with electronic transformer

Exemplary circuit diagram AKS-0816.03

